

RADIO'S LIVEST MAGAZINE



December
25 Cents

Radio-Craft

HUGO GERNSBACK Editor

1 Lb.
Radio Transmitter
Ascends 10 Miles

See Page 333



The Thyatron Inverter — An AC-DC Midget Set — An Electronic, Batteryless "PE" Cell
Servicing All-Wave Superhets — A New Electrolytic Condenser-Rectifier Power Pack

SPEED

RADIO TUBES FOR ALL NEW RECEIVERS

EVER ABREAST OF THE RADIO TIMES

SPEED has achieved tremendous success with these NEW tubes. The reason is obvious—QUALITY



247

New power amplifier Pentode, for use in the output stage of AC receivers.

Here They Are!

No. 235

New screen grid tube—designed to reduce cross modulation and similar distortion.

No. 551

New screen grid tube—designed for same purpose as type 235, although having slightly different characteristics.

No. 230

New general purpose tube, operating economically at 2 volts, giving unusual service though using very little power.

No. 231

New amplifier using 2 volts and extremely low current consumption in same group as types 230 and 232.

No. 232

New screen grid tube—for use as radio frequency amplifier, operating at 2 volts.

No. 233

New power amplifier in the Pentode group, operating on 2 volts with low current consumption.

No. 236

New screen grid tube used mainly as R.F. amplifier or detector in automobile sets. In same group as type 237 and 238. Also for use in D.C. sets.

No. 237

New general purpose tube—especially adapted to automobile use. Can be used either as a detector or amplifier. Also for use in D.C. sets.

No. 238

New power amplifier Pentode for use in automobile receivers designed for it. Gives unusual volume for small input signal strength.

No. S 84

Developed expressly for replacement of type C 484 in Sparton sets. Somewhat similar in characteristics to the type 227.

No. S 82 B

Developed expressly for replacement of the C 183 in Sparton sets, possessing all peculiar characteristics necessary for this purpose.

No. S 83

Developed expressly for replacement of the C 183 in Sparton sets, possessing all the peculiar characteristics necessary for this purpose.

SPEED Quality is Making History Today. Write for Complete Details.

Still another addition to a big family. **SPEED** FOTO-LECTRIC TUBES. Standard gas-filled type, red sensitive, caesium on caesium-oxide silver-oxide. Six months guarantee against defects. Write for FOTO-LECTRIC folder.



SPEED

CABLE RADIO TUBE CORPORATION

230-240 NORTH 9th STREET, BROOKLYN, NEW YORK

RCA
LICENSED

Train *with* R.T.A. *for* Radio Service Work

Important and far-reaching developments in Radio create sudden demand for specially equipped and specially trained Radio Service Men.



*This excellent
set analyzer
and trouble
shooter included
with our course
of training*

MANY skilled Radio Service Men are needed now to service all-electric sets. By becoming a certified R. T. A. Service Man, you can make big money, full time or spare time, and fit yourself for the big-pay opportunities that Radio offers.

We will quickly give you the training you need to qualify as a Radio Service Man . . . certify you . . . furnish you with a marvelous Radio Set Analyzer. This wonder instrument, together with our training, will enable you to compete successfully with experts who have been in the radio business for years. With its help you can quickly diagnose any ailing Radio set. The training we give you will enable you to make necessary analysis and repairs.

Serving as a "radio doctor" with this Radio Set Analyzer is but one of the many easy ways by which we help you make money out of Radio. Wiring rooms for Radio, installing and servicing sets for dealers, building and installing automobile Radio sets, constructing and installing short wave receivers . . . those are a few of the other ways in which our members are cashing in on Radio.

As a member of the Radio Training Association, you receive personal instruction from skilled Radio Engineers. Upon completion of the training, they will advise you personally on any problems which arise in your work. The Association will help you make money in your spare time, increase your pay, or start you in business. The easiest, quickest, best-paying way for you to get into Radio is by joining the Radio Training Association.

This amazing Radio Set Analyzer plus the instructions given you by the Association will transform you into an expert quickly. With it, you can locate troubles in all types of sets, test circuits, measure resistance and condenser capacities, detect defective tubes. Knowing how to make repairs is easy: knowing what the trouble is requires expert knowledge and a Radio Set Analyzer. With this Radio Set Analyzer, you will be able to give expert service and make big money. Possessing this set analyzer and knowing how to use it will be but one of the benefits that will be yours as a member of the R. T. A.

Write for No-Cost Membership Plan

We have worked out a plan whereby a membership enrollment need not cost you a cent. Our thorough training and the valuable Radio set analyzer can be yours. Write at once and find out how easily both of these can be earned.

Now is the time to prepare to be a Radio Service Man. Greater opportunities are opening up right along. For the sake of extra money in your spare time, bigger pay, a business of your own, a position with a future, get in touch with the Radio Training Association of America now.

Send for this No-Cost Membership plan and Free Radio Handbook that will open your eyes as to what Radio has in store for the ambitious man. Don't wait. Do it now.

RADIO TRAINING ASSOCIATION OF AMERICA
Dept. RCA-12 4513 Ravenswood Ave. Chicago, Ill.

Fill Out and Mail Today!

RADIO TRAINING ASSOCIATION OF AMERICA
Dept. RCA-12, 4513 Ravenswood Ave., Chicago, Ill.

Gentlemen: Send me details of your No-Cost Membership Enrollment Plan and information on how to learn to make real money in radio quick.

Name

Address

City..... State.....

H. GERNSBACK, President
 S. GERNSBACK, Treasurer
 J. M. HERZBERG, Vice-President
 I. S. MANHEIMER, Secretary



R. D. WASHBURNE,
 Technical Editor

LOUIS MARTIN
 Associate Editor

VOLUME III
 NUMBER 6

Contents of This Issue

DECEMBER
 1931

	PAGE		PAGE
EDITORIAL:			
Radio Education.....	By Hugo Gernsback 331	An Inexpensive Capacity Meter.....	By E. M. Hanken 348
NEW DEVELOPMENTS IN RADIO:			
The Thyatron Inverter.....	By L. van der Mel 332	Adapter for Testing Rectifiers.....	By Alfred Pogany 349
The U. S. Signal Corps Balloon Radio.....	333	Calibrating Voltmeters.....	By A. R. Haidell 349
Burlesque Advertisements	334	An Improvement in Ohmmeters	
New Devices in Radio.....	336		By C. Porter Ferrell 349
SERVICE MEN'S DEPARTMENT:			
The Antenaplex System.....	By E. Jay Quinby 339	Operating Notes.....	By Bertram M. Freed 350
Magic in Meters (Part II).....	By Clifford E. Denton 342	Servicing Majestics.....	By Jas. P. Smith 351
An Electrolytic-Condenser-Rectifier		Service-Selling "All-Wave" Supers	
	By P. M. Jarowey 344		By McMurdo Silver 354
The Service Man's Forum.....	345	Variable Resistors.....	By L. van der Mel 361
"Killing" Service Calls.....	By Henry H. Klappert 345	SOUND RECORDING DEPARTMENT:	
RADIO SERVICE DATA SHEETS:			
No. 55—Kolster-International Models K-60 and K-62..	346	Recording Studio Design.....	By Geo. J. Saliba 352
No. 56—U. S. Radio and Television Models 90 and		TECHNICAL RADIO TOPICS:	
99 X Superheterodyne Receivers.....	347	R. F. Coil Design.....	By C. W. Palmer 338
Favorite Testing Equipment		Sound Equipment in the Hotel New Yorker, (Part V);	
A One-Meter Service Unit.....	By Henry E. Sible 348	Speech Input Equipment.....	By Eli M. Lurie 340
		The A.C.-D.C. Portable-L.....	By H. G. Cisin 353
		Radio Short-Cuts.....	By RADIO-CRAFT Readers 358
		The Radio Craftsman's Page.....	By Himself 360
		RADIO-CRAFT's Information Bureau.....	362

In Forthcoming Issues

THE REMOTE-CONTROLLED PIANO. An interesting description of the manner in which a musical instructor may instruct remote students.

A REGENERATIVE STATIC REDUCER. Experimental models of this receiver design indicate a definite reduction of static interference.

THE PUSH-PUSH AMPLIFIER. A technical description of a new development in audio amplifier design, a push-pull amplifier biased to cut-off of plate current.

THE 6 V. D.C. to 110 V. A.C. "AUTOVERTER." A description of a new commercial unit operating on current-conversion principles described in past issues of RADIO-CRAFT.

RADIO-CRAFT is published monthly, on the fifth of the month preceding that of date; its subscription price is \$2.50 per year. (In Canada and foreign countries, \$3.00 a year to cover additional postage.) Entered at the postoffice at Mt. Morris, Ill., as second-class matter under the act of March 3, 1879. Trademarks and copyrights by permission of Gernsback Publications, Inc., 98 Park Place, New York City.

Text and illustrations of this magazine are copyright and must not be reproduced without permission of the copyright owners. We are also agents for WONDER STORIES and WONDER STORIES QUARTERLY. Subscriptions to these magazines may be taken in combination with RADIO-CRAFT at reduced Club rates. Write for information.

Copyright 1931, GERNSBACK PUBLICATIONS, INC.

Published by
TECHNI-CRAFT PUBLISHING CORPORATION

Publication Office: 404 No. Wesley Ave., Mount Morris, Illinois

Editorial and Advertising Offices
 96-98 Park Place, New York City

Chicago Advertising Office
 737 North Michigan Avenue, Chicago, Ill.

Western Advertising Office
 220 No. Catalina St., Los Angeles, Calif.

L. F. MCCLURE, Chicago Advertising Representative

LOYD B. CHAPPELL, Western Advertising Representative

London Agent: Hachette & Co.,
 3 La Belle Sauvage, Ludgate Hill, E.C. 4

Paris Agent: Hachette & Co.,
 111 Rue Reaumur

Australian Agent: McGill's Agency,
 179 Elizabeth St., Melbourne

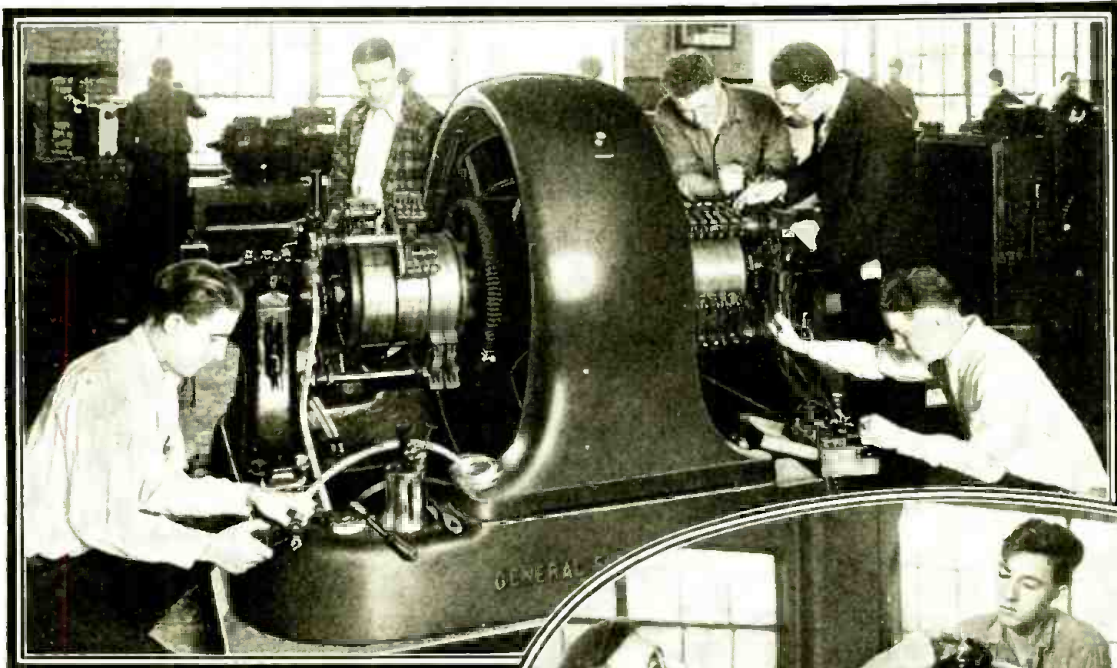

Coyne students getting actual experience on one of my big synchronous converters!

One of my Instructors explaining the operation of a radial airplane engine.



A BIG PAY JOB for YOU in ELECTRICITY

Don't spend your life in a dull, hopeless job! Don't be satisfied with a mere \$30.00 or \$40.00 a week! You don't have to! Electricity pays salaries of \$60.00, \$70.00 and more a week to thousands of fellows probably no smarter than you.

Learn By Actual Shop Work in 90 Days No Useless Theory

Come to Coyne at Chicago and learn Electricity in 90 days—not by correspondence, but by actual electrical work—on huge motors and generators, switchboards, power plants, substations, auto and airplane engines, armatures, etc. You don't need advanced education or previous experience. Coyne has been placing men in Big Pay Electrical Jobs since 1899. Let Coyne help you to a good electrical position.

Free Employment Service Earn As You Learn

My Employment Department gives you a FREE life-time service. And if you'll need part-time work while at school to help pay living expenses, we'll gladly help you get it. MAIL COUPON FOR FREE PROOF THAT YOU CAN PREPARE FOR A GOOD ELECTRICAL JOB IN 90 DAYS! Get my Big Free Electrical Book—FREE Radio Service and Auto Electrical offers. Find out about my special low tuition. This does not obligate you in any way. JUST MAIL THE COUPON!

COYNE ELECTRICAL SCHOOL
H. C. LEWIS, President Founded 1899
500 S. Paulina St., Dept. 91-81 Chicago, Illinois

JOBS PAYING \$60 to \$200 a week

- Power Plant Operator \$50 to \$70 a wk.
- Maintenance Engineer 60 to 100 a wk.
- Armature Winding . . . 45 to 75 a wk.
- Illumination Expert . . . 50 to 80 a wk.
- Radio Service Expert 50 to 100 a wk.
- Aviation Ignition . . . 60 to 125 a wk.
- Battery Expert . . . 70 to 200 a wk.
- Auto Electrician . . . 75 to 200 a wk.
- Contractor-Dealer . . . 60 to 300 a wk.
- Signal Engineering . . . 50 to 100 a wk.

FREE ELECTRICAL BOOK Coupon

H. C. LEWIS, PRESIDENT
COYNE ELECTRICAL SCHOOL, Dept. 91-81
500 South Paulina Street, Chicago, Illinois.

Gentlemen: Please send me your big Free Electrical Book with 151 Illustrations. This does not obligate me.

Name

Address

City State

**A *Better* TUBE¹
KEEPS
A Customer
LONGER
Satisfied**



WHEN you speak about the replacement —you should talk PERRYMAN.* You as counsel to your customers must be backed by a tube of outstanding quality. PERRYMAN tubes meet the most exacting requirements and will build permanent good will and an ever increasing volume of sales for you.



Your stock should include a varied supply of PERRYMAN Tubes. Write Dept. RC for the name of nearest wholesale distributor; also our special proposition for service men.

PERRYMAN Tube production has increased steadily during the past few months to keep pace with the demand for new tubes. The new low list prices have been carefully adjusted to enable dealers and servicemen to make a fair profit—PERRYMAN Replacement Policy assures recommendation by others for new tubes.

PERRYMAN ELECTRIC CO.
INCORPORATED

NORTH BERGEN :: :: NEW JERSEY

PERRYMAN



RADIO TUBES

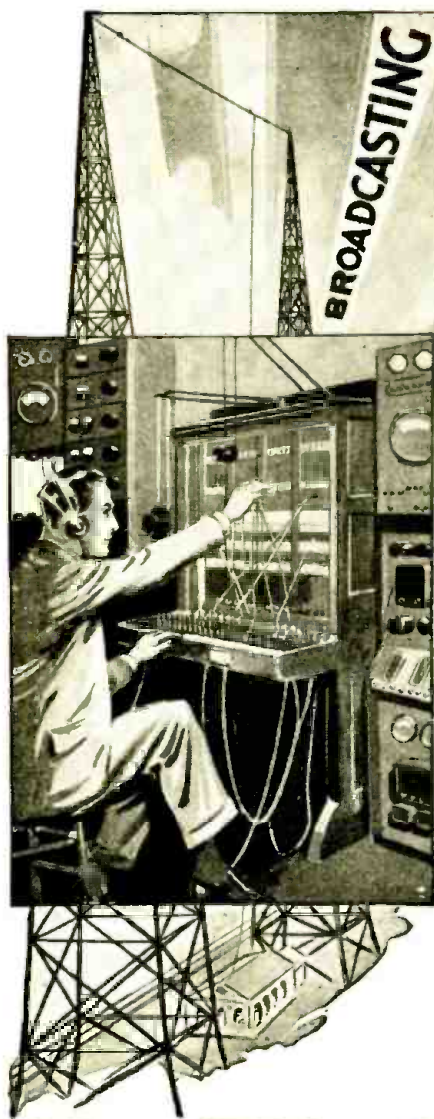

BROADCASTING
TELEVISION
TALKING PICTURES
WIRELESS OPERATING

WIN FAME and FORTUNE in RADIO!

Scores of jobs are open to the Trained Man—jobs as Designer, Inspector and Tester—as Radio Salesman and in Service and Installation work—as Operator, Mechanic or Manager of a Broadcasting station—as Wireless Operator on a Ship or Airplane—jobs with Talking Picture Theatres and Manufacturers of Sound Equipment—with Television Laboratories and Studios—fascinating jobs, offering unlimited opportunities to the Trained Man.

Ten Weeks of Shop Training

Come to Coyne in Chicago and prepare for these jobs the QUICK and PRACTICAL way—BY ACTUAL SHOP WORK ON ACTUAL RADIO EQUIPMENT. Some students finish the entire course in 8 weeks. The average time is only 10 weeks. But you can stay as long as you please, at no extra cost to you. No previous experience necessary.

TELEVISION and Talking Pictures

In addition to the most modern Radio equipment, we have installed in our shops a complete model Broadcasting Station, with sound-proof

Studio and modern Transmitter with 1,000 watt tubes—the Jenkins Television Transmitter with dozens of home-type Television receiving sets—and a complete Talking Picture installation for both “sound on film” and “sound on disk.” We have spared no expense in our effort to make your training as COMPLETE and PRACTICAL as possible.

Free Employment Service to Students

After you have finished the course, we will do all we can to help you find the job you want. We employ three men on a full time basis whose sole job is to help our students in finding positions. And should you be a little short of funds, we'll gladly help you in finding part-time work

while at school. Some of our students pay a large part of their living expenses in this way.

Coyne Is 32 Years Old

Coyne has been located right here in Chicago since 1899. Coyne Training is tested—proven by hundreds of successful graduates. You can get all the facts—FREE. JUST MAIL THE COUPON FOR A FREE COPY OF OUR BIG RADIO AND TELEVISION BOOK, telling all about jobs . . . salaries . . . opportunities. This does not obligate you. Just mail the coupon.

H. C. Lewis, Pres. **Radio Division** Founded 1899
Coyne Electrical School
 500 S. Paulina Street Dept. 91-8H Chicago, Illinois

H. C. LEWIS, President
 Radio Division. Coyne Electrical School
 500 S. Paulina St., Dept. 91-8H, Chicago, Ill.
 Send me your Big Free Radio, Television and Talking Picture Book. This does not obligate me in any way.

Name.....
 Address.....
 City..... State.....

FREE Supplements are mailed every 60 days to owners of the 1932 Official Radio Service Manual

FREE Questions and Answers Service

Schematic Diagrams of All Latest Midget Receivers

Expert servicing or installation of radio receivers requires that the dealer, service man or radiotrician be thoroughly experienced in handling sets of any manufacture. Needless to mention how important are modern methods of servicing, and how easy it is to complete any service job when the OFFICIAL RADIO SERVICE MANUAL is on hand. The NEW 1932 MANUAL contains a Full Radio Service Guide and a most Complete Directory of all 1931-1932 Radio Receivers as well as models of older design. Everyone employed in the Radio Industry should have a copy available for his own use.

\$5.00

The Copy

HUGO GERNSBACK,
Editor

C. E. Denton
Managing Editor

Clyde Fitch,
Managing Editor

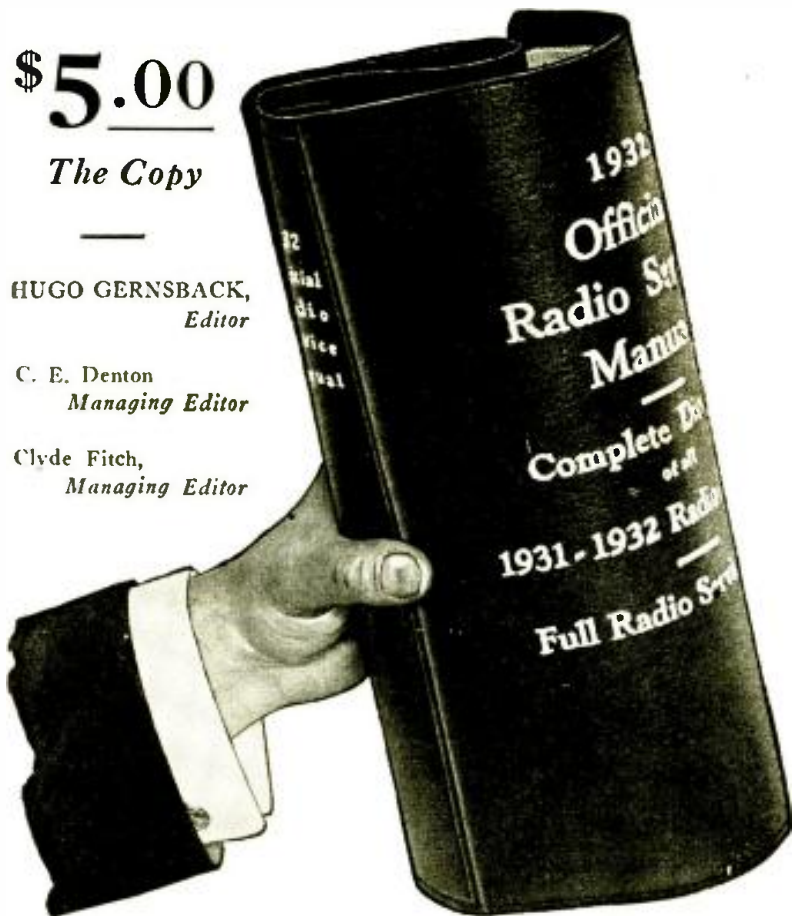

Partial Contents of the Manual

A step-by-step analysis in servicing a receiver which embodies in its design every possible combination of modern radio practice; it is fully illustrated and thoroughly explained. It is the greatest contribution to the radio service field.

Chart showing the operation of all types of vacuum tubes, whether new, old or obsolete. An exclusive resumé of the uses of the Pentode and Variable Mu Tubes and their characteristics.

Complete discussion of the superheterodyne and its inherent peculiarities. Also a special chapter on tools used on superheterodyne circuits.

Schematic diagrams and circuits complete with color codings.

Important chapters on commercial aircraft radio equipment; new data on commercial short wave receivers and converters.

Servicing and installation of public address systems and talking machine equipment.

Standardized color codings for resistors.

Operation of old and new testing equipment; tube voltmeters, output meters, oscillators and aligning tools.

A full section on Midget radios—their design, circuits and types. How to service them most economically.

Hundreds of schematic diagrams of older radio receivers which have never been published.

Blank pages for recording notes, diagrams and sketches; these pages are transferable to any part of the book.

OVER 1,000 PAGES

Over 2,000 Diagrams, Charts and Illustrations

Flexible Loose Leaf Binder
9 x 12 Inches

Complete Directory of All 1931-1932 Radio Receivers
Full Radio Service Guide For Radio Service Men, Dealers, Jobbers, Manufacturers and Set Builders

Clip Coupon NOW!

GERNSBACK PUBLICATIONS, Inc.,		HC-12
96-98 Park Place, New York, N. Y.		
I enclose herewith remittance of \$5.00, check or money order preferred, for which you are to send me the NEW 1932 OFFICIAL RADIO SERVICE MANUAL. I understand that all the New material will be included in the Manual and Supplements will be mailed FREE every 60 days.		
Name		
Address		
City	State	

“For 16 Weeks



I enjoyed every broadcast from VK3ME MELBOURNE, AUSTRALIA”

This is not a “freak” record. Hundreds of other Scott All-Wave Receivers—all summer long—have brought their owners loud, clear, perfect music and song from the other side of the world.

EVERY now and then, the story of some phenomenal instance of extremely long distance radio reception breaks into the press. DX fans usually find little interest in such stories because they know the performance which they relate is invariably due to “freak” conditions.

But DX fans KNOW, when my receiver brings in every broadcast from VK3ME for 16 consecutive weeks, that full credit must go to the receiver that did the work. And when they learn that hundreds of other receivers exactly like mine, and located in all parts of the world, are piling up equally sensational records, they are well satisfied that the Scott All-Wave is not only the most powerful, most sensitive receiver possible to obtain, but the one receiver that fulfills their lifelong hopes.

Undeniable Proof

Away last spring I made up my mind to eclipse all standards of radio reception—distance—power—selectivity and tone. I believed the Scott All-Wave would do it, so I set out to make a day-to-day log of VK3ME, Melbourne, 9560 miles away from my receiver. I tuned in every broadcast, on the loud speaker, and to prove to the entire world that I heard every VK3ME program with full volume, and with perfect tone and clarity, I made a disc recording of every broadcast! Half of these records I sent to VK3ME. The others are at my laboratory and will be played for anybody who asks to hear them.

Not a Special Set

The Scott All-Wave Receiver that you may buy, will in no way, differ from the one I used in my 16-week test. It will be identical to the hundreds of other Scott All-Wave Receivers that tune in voice from England, France, Germany, Italy, Japan, Indo-China, and South America every day in the week—summer and win-



ter. The set that I will send to you will actually be tested on reception from G5SW, Chelmsford, England, or 12RO, Rome, Italy, before shipping!

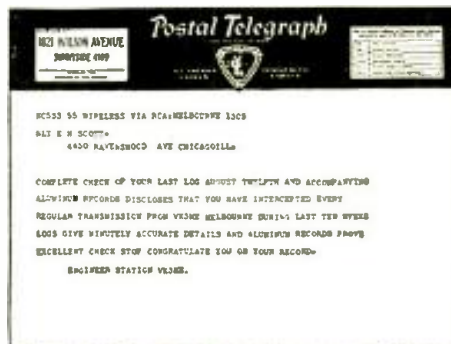

This cablegram verifies the first 10 weeks' reception. To date there has not been time for my log of the last 6 weeks to reach Melbourne.

E. H. SCOTT RADIO LABORATORIES, Inc. (Formerly Scott Transformer Co.)
4450 Ravenswood Avenue - Dept. C12 - Chicago, Illinois

The SCOTT ALL-WAVE

15-550 METER SUPERHETERODYNE

Another Challenge

Again, I challenge the whole world of radio to any kind of competitive test, between 15 and 550 meters. I guarantee that the Scott All-Wave will bring in the most stations between 15 and 550 meters—that the Scott All-Wave will leave no doubt as to superior tone quality—and that it will give actual 10 kilocycle selectivity over the Broadcast Band.

Clip the coupon—mail it today for full particulars. You'll be amazed when you see how little it costs to own a Scott All-Wave Superheterodyne.

E. H. Scott
CLIP-----

E. H. SCOTT RADIO LABORATORIES, Inc.
(Formerly Scott Transformer Co.)

4450 Ravenswood Ave., Dept. C12, Chicago, Ill.

Send me full particulars of the Scott All-Wave Receiver.

Name.....

Street.....

Town.....State.....

WELCOME



Dealers' net price
f.o.b. Greenwood, Miss.

Smaller, lighter, handier case. A combined test panel and portable lab. Mounts on the wall as easily as removing the lid.

\$147.50

MODEL 60

A new handy oscillator designed for use with any output meter such as provided in the Model 90 Analyzer. Each instrument individually calibrated covering all ranges from 90 to 1500 kilocycles. Completely shielded in case aluminum tray with bakelite covered aluminum panel. 100% modulation—complete attenuation without leakage even with the most sensitive receivers. The biggest value in a really precision instrument ever offered.



Dealers' net price
f.o.b. Greenwood, Miss.

\$30.00

Portable type (illustrated)

\$3.00 extra

SERVICE with NEW SUPREME

More "old" radios in every community—fewer new sets—forecast radio's greatest service season. Forcing another season of usefulness out of millions of old sets inevitably means tremendous parts replacements and service calls.

SUPREME DIAGNOMETER AAA1

5 ultra-modern, essential testing instruments in **1**

Acclaimed by the radio service world as "the biggest thing in Radio since '28," the SUPREME DIAGNOMETER, AAA1, combines in the one handy case, the versatility of a SUPER-DIAGNOMETER, plus SHIELDED OSCILLATOR, plus ADVANCED TUBE TESTER, plus OHM-MEGOHMMETER, plus CAPACITOR TESTER—5 ultra-modern instruments in one at the price of 1.

The result of many months' experimental development and trial, it is conceded by technicians as the most revolutionary and complete testing instrument ever produced.

RADIO'S GREATEST

SEASON testing EQUIPMENT

Smart radio men who know what it means in dollars and cents to stand at the top of their profession with equipment that insures economical service for themselves and their clients, are welcoming this season of opportunity with "New" SUPREME, TESTING INSTRUMENTS.



Supreme Oscillator Model 70

A thoroughly shielded, completely attenuated oscillator of the highest type. Combined oscillator—output meter—high resistance ohmmeter can be obtained in a beautiful hardwood carrying case providing unequalled flexibility in service ranges. Send coupon for details.

Dealers' net price f. o. b. Greenwood, Miss.

Supreme Oscillator Model 70. **\$49.75**
Less tubes and batteries

Supreme Output-Ohmmeter **\$30.00**

Handsome Carrying Case of hardwood for combined Oscillator, Output-Ohmmeter and Accessories **\$5.00**

ASK YOUR JOBBER FOR DEMONSTRATION
All leading jobbers can demonstrate the economy and investment value of "SUPREME" TESTING INSTRUMENTS. If you can't, indicate on coupon what instrument interested in and name of jobber. Welcome Radio's greatest service season with up to date testing equipment—the SUPREME way.

Distributors in all principal cities

Foreign Division,
130 West 42nd St., New York City
Cable Address Lopreh New York

Supreme Analyzer Model 90

Dealers' net price f. o. b. Greenwood, Miss. (illustrated) Portable type

\$78.50

A new Model 90 Analyzer borrowing some of the tremendous features of the AAA1 DIAGNOMETER. Greater simplicity, greater range and speed. Analysis of screen grid and Variable-Mu circuits without oscillation and complete analysis of r.f. and power pentode circuits. The only analyzer providing complete rectifier circuit analysis, including helium rectifiers and providing direct readings of resistance values up to 500,000 ohms in two ranges utilizing the same 4.5 volt battery potential provided in the analyzer. There is no analyzer on the market today remotely approaching the servicing range and elasticity of the new Model 90.



Supreme Model 40

A tube tester of improved design equal to instruments selling for double its modest price. Tests all tubes without adapters, including power and r.f. pentodes and provides for filament or heater potentials of 1.5, 2.0, 3.3, 5.0, 6.3, and 7.5 volts to any of the five sockets on the panel—a very flexible arrangement. A "grid shift" test of all amplifiers is provided with a biasing arrangement automatically determined by the plate current load of the tube under test, so that the controlling grid biasing potential may be observed on the meter. Incorporates a gas test for amplifiers, a cathode-heater short test for heater types, and tests both plates of full wave rectifiers. Everything that could be desired in a high class, efficient tube tester—and at a price that fits the pocket book.

Dealers' net price f. o. b. Greenwood, Miss.

\$30.00
Portable type (illustrated) **\$3.00 extra**



SUPREME INSTRUMENTS CORPORATION

420 Supreme Building, Greenwood, Miss.

Please send me full particulars on SUPREME DIAGNOMETER AAA1 SUPREME MODEL 40
 SUPREME SET ANALYZER MODEL 90 SUPREME MODEL 60 SUPREME MODEL 70

Name _____
Address _____
City _____ State _____
Jobber's Name _____
City _____ State _____



The Top of the World is our "Proving Ground"

The arctic is hardly the ideal place to test radio equipment. Severe magnetic disturbances, violent electrical storms and the Aurora Borealis conspire to make radio communication extremely difficult if not actually impossible. Yet, Lincoln engineers used the polar regions as the proving ground for Lincoln equipment.

The schooner "Bowdoin" of the MacMillan Arctic Expedition was Lincoln equipped, and for the first time in the twelve year history of this famous expedition contact with Chicago was maintained *daily*! Not only were daily short-wave messages received clearly and consistently but broadcast programs and contacts with 17 foreign countries were enjoyed! Such remarkable performance won high praise from members of the expedition and set a new record of performance under the most adverse conditions.

As if this were not alone sufficient to firmly establish Lincoln leadership, the exclusive Lindbergh news scoop

again focused national and international attention upon the phenomenal capabilities of Lincoln equipment. When, on August 5, Col. and Mrs. Lindbergh were feared lost in the arctic wilderness, a Chicago operator sitting at his Lincoln receiver caught the anxiously awaited signal from the speeding plane. The message was relayed to the press and within a few hours the story, with a detailed account of the actual interchange of signals, headlined in 965 papers throughout the country.

Nor are such spectacular achievements confined solely to arctic expeditions. Lincoln receivers, in thousands of homes, are consistently outperforming every other known type of equipment. Super-power under perfect control gives the new Lincoln tremendous range, and the specially designed audio system endows Lincoln receivers with a rich, vibrant, life-like tone. A Lincoln Radio is your assurance that you possess the ultimate in design, quality and performance.

The Famous Lincoln Chassis

Both the Lincoln DeLuxe SW-32 and DeLuxe DC-SW-10 are identical in design, both utilizing the high power of ten tubes. The DC-SW-10 has a very low drain and operates on dry "B" batteries and any two (2) volt "A" supply.

Elimination of AC line interference makes the DC-SW-10 desirable in city communities.

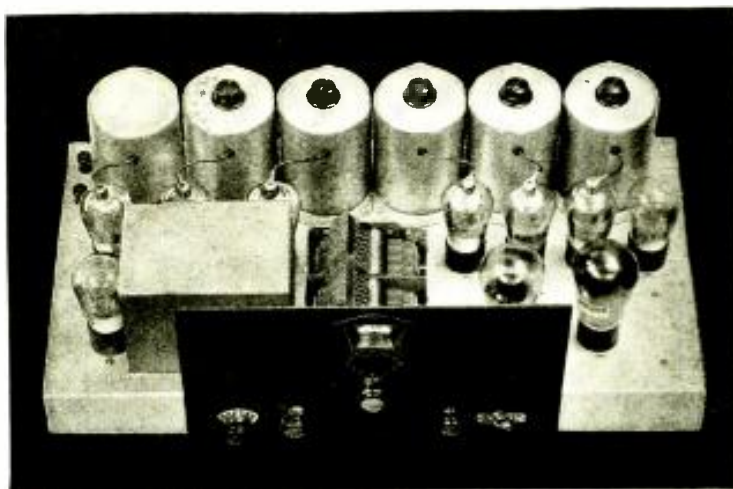

Illustrated, the Lincoln DeLuxe SW-32, an AC model. This same chassis may be had in the DC model, the Lincoln DeLuxe DC-SW-10.



World-Wide Reception without Plug-in Coils!!

Imagine being able to tune in short-wave stations in every corner of the globe with the same ease and certainty of turning your local broadcast station! Imagine having the entire world of radio at your finger tips—air-mail, amateur phone, short-wave broadcast, police. Trans-Atlantic phone, and all the other fascinating features of the air at your command without having to change a coil or disturb a single connection! Imagine tone of actual life-like fidelity, rich and vibrant with all of the subtle overtones and harmonics preserved intact! It has been the dream of every radio enthusiast, and now such a receiver is here!

The new Lincoln DeLuxe SW-32 embodies all of these features. Broadcast and short-waves are received with equal ease. Plug-in coils have been banished forever—a small no-capacity selector switch on the front panel gives instantaneous access to either broadcast or any of the short-wave bands. A low-high power switch gives added power for the DX fan. The low-power position is sufficient for full loud speaker volume on stations within 500 or 1000 miles, the high-power position for 'round the world reception.

Super-power, developed by Lincoln engineers, gives an entirely new conception of radio performance. A Lincoln owner in Tennessee listens to 92 foreign short-wave stations out of a total of 128 foreign phone stations. From Cushing, Oklahoma, comes the report, "Seven stations received from Japan one morning, all in the broadcast band." Another Lincoln owner says, "Listening to 2YA Wellington, New Zealand, Osaka, Sendai, and Kumamoto, (750, 770, 790 KC) in Japan, KGMC in Honolulu, 2BL Sydney, Australia, all in the broadcast band."

Such astounding feats are by no means exceptional. Lincoln receivers are built to give outstanding service. Constructed by competent engineers to the highest standards of laboratory precision, each Lincoln receiver is pledged to outperform any other radio equipment known! The tremendous amplification of four stages of tuned I. F. transformation give the Lincoln receiver power and range unheard of before. A specially designed audio system produces tone of amazing quality. From the sweet liquid note of the clarinet to the rich resonant bass viol, every instrument and every voice is brought to your home with all of the timbre and quality of the living artist. Speakers, specially built for the Lincoln receivers insure faithful reproduction of the audio output.

May we not send you an illustrated folder describing each model in detail?

Lincoln Radio Corporation
Dept. R.C.-12, 329 So. Wood St.
Chicago, Illinois.

Will you please send illustrated folder describing the Lincoln DeLuxe "32" models.

Name.....
Street.....
City..... State.....

LINCOLN RADIO CORPORATION
329 S. Wood St., Dept. R. C.-12, CHICAGO, ILL.

DECEMBER
1931
VOL. III—No. 6



HUGO GERNSBACK
Editor

“Takes the Resistance Out of Radio”

Editorial Offices, 96-98 Park Place, New York, N. Y.

Radio Education

By HUGO GERNSBACK

I AM frequently asked by many of my readers what steps I would recommend for them to obtain a good radio education. My correspondents are usually vague as to what course they wish to pursue, since they specify simply “radio,” with no qualification as to any particular branch of the science.

At the outset, I must point out that radio today is such a tremendously involved industry that it is well-nigh impossible for any man to know everything connected with it. A radio tube expert is so far removed from the radio broadcast expert that the two have little in common; they might just as well work in entirely different lines. In fact, they really do.

Before it is possible to state much about this or that radio education, the seeker of knowledge must have a definite purpose in mind. He must know in advance which section of the radio field attracts him most. If he has never had any experience in any of the various branches of radio, then I would suggest that he first take a course, which might be either by correspondence or by personal instruction, with any of the many excellent radio schools with which this country abounds. This, then, will give the prospect an idea of the branch of radio he will finally choose.

A radio education should start off primarily with books which deal with the different subjects in the field. There are, of course, books treating radio generally and giving an outline of the different branches of the subject, but the books on the specialized applications are the most important which the future radio man will have to study.

Of course, every student in radio should have a general knowledge of its various branches, although it will be impossible to master all of them perfectly. In due time the student will choose, if he intends to be successful, a certain branch and specialize in that branch if possible.

I consider it, however, of paramount importance that, no matter what the radio student does, he should have an excellent knowledge of electricity; because without this background, it will be difficult to accomplish much in the profession.

Then, to my mind, the future radio man should not neglect taking a course in a resident radio school, which is very important. I consider the practical information thus gained of the highest possible importance, because those things which one does with his own hands give him experience and knowledge which cannot be obtained in any other way. Of course, the same purpose can be achieved in a laboratory or a factory; but

the radio education here will be, at best, more or less one-sided because, in few factories, and in few laboratories, will the student have at his disposal all of the different machinery, apparatus, etc., which he will encounter in a well-equipped resident school.

All of these previous remarks, naturally, are only general, and cannot fit each and every case. For instance, the man who wants to become a radio tube engineer will have to traverse a somewhat different path; although the elementary groundwork, that is, electricity, then book and practical knowledge gained in a resident school, will also apply as a general groundwork toward a future education.

Yet the tube engineer must have other knowledge besides purely electrical and radio. He must, in the first place, be a good physicist. He must also be well versed in mathematics, and he should know something about metallurgy and glass. He should also know something about the finer mechanics, for the reason that modern vacuum tubes are highly intricate from a mechanical viewpoint and, indeed, the entire art is tending to become as delicate in its technique as watchmaking.

These facts would seem to be self-evident; but it is surprising how few students pay much attention to such details, with the result that many make a wrong start and become “third-raters” in their chosen field when they could rate first just as well.

Every branch of radio is tremendously complicated, and only those who are well-equipped mentally in every sub-division of the branch will make a success in the end.

And then, to be sure, a radio education is never finished. When the preliminary education has been completed, then study begins in earnest, and never stops. It then becomes necessary to get hold of every scrap of printed information in the particular branch of the art. Even a month's neglect of the current literature is often sufficient to make a man a “back-number,” even if only temporarily so. Not only must the newest and latest advances in the art be studied from the public's viewpoint, but one's competitors must be watched closely, in the present trend of the times, and their activities followed avidly from day to day.

And even, when all of this is accomplished, the most brilliant men in the radio profession will tell you, that the higher their own education the less they themselves consider it complete; because the more we learn, the more we understand how little we actually know of any one subject. It is only those with limited knowledge who consider that they have learned all there is to know in any line.

110
VOLTS
D. C.
INPUT

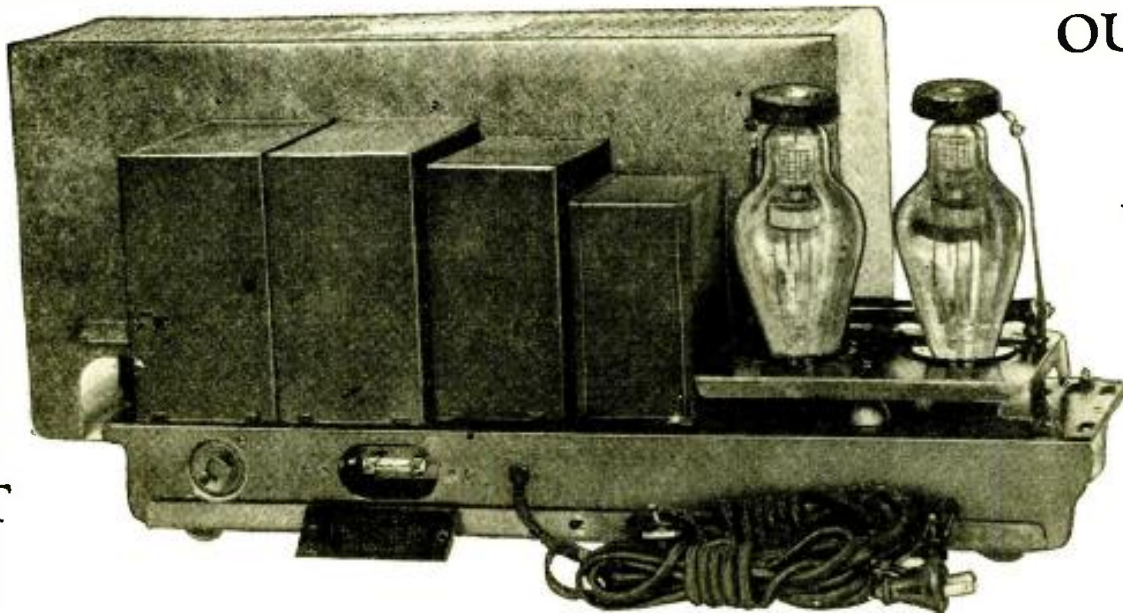

OUTPUT
110
VOLTS
A. C.

The THYRATRON Inverter

By L. VAN DER MEL

EVER since the advent of the alternating current receiver with its tremendous inherent advantages over those operated by batteries, there has been an insistent demand for better quality and more volume. This demand is gradually being satisfied as new tubes, circuits, and speakers are being developed. But to the man who lives in direct current districts, the modern advancements have not been applied.

Although satisfactory operation of radio receivers in locations supplied with direct current has been obtained in the past, they have been handicapped by certain inherent limitations of this type of power. These limitations fall in the following general classifications:

In view of the low voltage usually available in direct current, and the fact that it is impossible, within economic reason, to raise this voltage, the output of D.C. receivers is lower than that of receivers supplied with alternating current.

Even with inferior performance the choice of D.C. model receivers is necessarily small due to the small market in which they may be sold.

While the use of a motor generator set or a converter may be had in conjunction with A.C. receivers in D.C. districts, it is not recommended in view of the obvious undesirability of having rotating machinery in the home. The electrical and mechanical noises accompanied with such machinery, together with the additional cost of filters necessary to obviate the noises, raise the cost of the receiver sometimes to a prohibitive value.

The motors usually used for phonograph work are of the synchronous type, and because of the variation in frequency of the voltage output of small rotating machines, they can not be successfully used.

All of the above reasons have created a demand for a device that would facilitate the operation of A.C. receivers from a D.C. source. This demand has been satisfied by the development of a new type of converter called the Thyatron Inverter, model "TH-10" designed by the RCA Victor Co.

Briefly, the Thyatron is a three element gas-filled tube that has characteristics such that it may convert D.C. into A.C. (This tube has been discussed in detail in the September 1930 issue of RADIO-CRAFT). It consists of an indirectly heated cathode, grid, anode or plate, and a globule of mercury. The heater is operated at the D.C. line voltage, i.e., 105-125 volts.

The component parts of the Inverter consist of a grid exciter transformer, automatic starting and frequency control circuits, plate commutation capacitor, limiting reactor, and a radio frequency filter system.

The principle of operation of the Inverter is quite simple, being that of an oscillating circuit at 60 cycles. The Thyratrons (two of them being used in this set) supply power in pulses to a circuit consisting of inductance and capacity. The circuit is tuned to a frequency of 60 cycles, and thus generates the A.C. power necessary to operate the receiver in a manner similar to any other alternating current set.

The A.C. power generated is sufficient not only to operate the radio set, but a phonograph motor, the maximum total power that may be drawn being 225 watts.

The advantages to be gained by the use of the Thyatron tubes rather than rotating machinery are noiseless operation (both electrical and mechanical), lack of moving parts, can be housed in the cabinet of the receiver proper, and will allow the full use of the maximum sensitivity of the receiver.

The device is 10½ ins. wide, 10½ ins. high, 5¾ ins. deep and weighs 39 pounds. A photograph of the finished product is illustrated above. This is a rear view and the Thyratrons are clearly visible.

As more details regarding this interesting device are received, they will be published in RADIO-CRAFT.

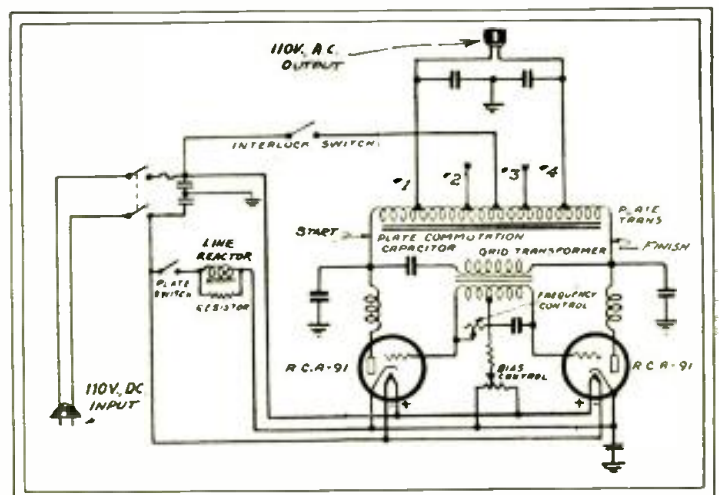

The schematic diagram of the Thyatron Inverter is shown above. When 110 volts D.C. are applied to the input, 110 volts A.C. is obtained at the output.

The U. S. Signal Corps BALLOON RADIO

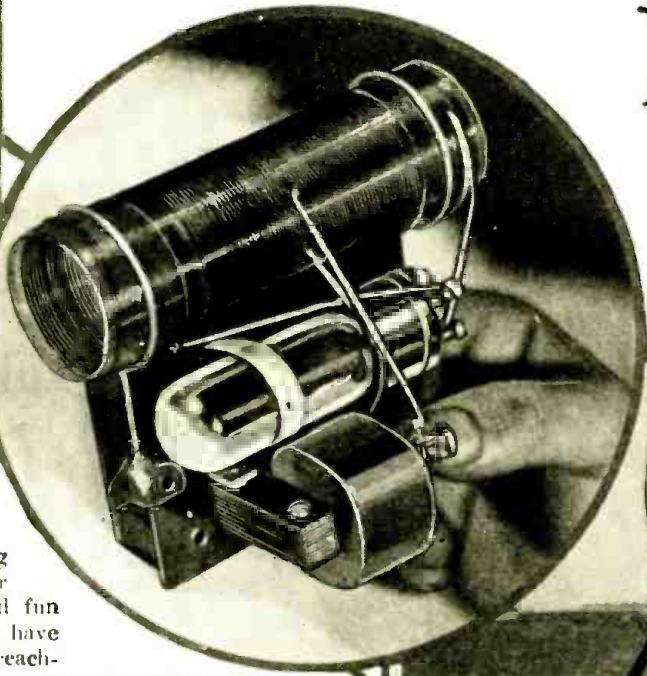

The one pound transmitter illustrated in the center photograph ascends to a height of 10 miles to facilitate the taking of meteorological observations.

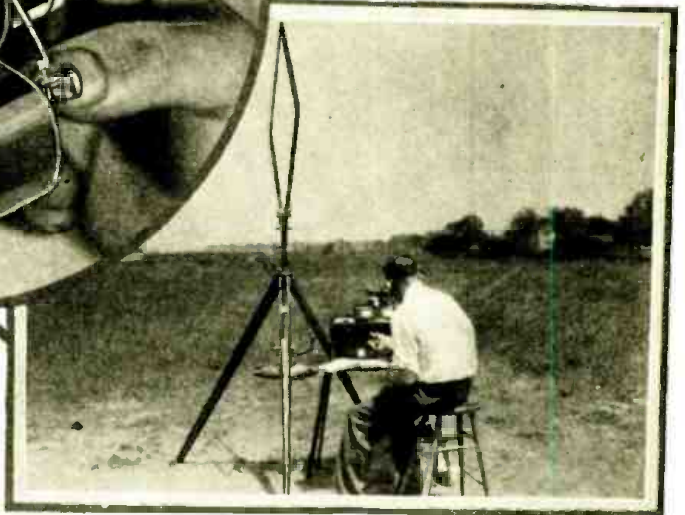

MANY of us have, at one time or another, purchased small gas-filled balloons, tied a string to them and watched them soar up into the atmosphere. It was good fun when we were young, but most of us have avoided this means of enjoyment upon reaching maturity. The United States Army, however, still persists in indulging in this form of entertainment, only now for serious purposes.

Meteorological observations conducted by the United States Army to determine the condition of the upper strata such as air temperature, pressure, humidity, and direction and speed of movement, for military, industrial, and weather forecasting purposes, make use of small balloons for obtaining this information. When observations only of wind direction and speed are required, the procedure is to send aloft small balloons of about six inches (uninflated) in diameter and follow them with theodolites. The rates of ascension may easily be calculated with a knowledge of their weight, dimensions, and free lift of the balloon. Only a small amount of additional calculation is then necessary to determine the position of the balloon at given intervals of time, usually one minute.

This method of determining the characteristics of the atmosphere has many inherent faults. The length of time involved in the final calculations, the effect of fog and rain, especially at night, and the general instability of the method, all were instrumental in determining whether or not radio might be used to determine the path of the balloon during its flight.

In 1923 the Signal Corps Laboratories at McCook Field started a series of experiments whose purpose was to develop a transmitter and receiver which would be suitable for this work. The project was dropped for a time, but was recently taken up again by the Signal Corps Laboratories at Fort Monmouth. It is not necessary to enter into a discussion of the various circuits that were tried during the

course of the experiments, and consequently we will confine our attention only to the final products.

The Transmitter

The transmitter finally selected is shown in Fig. A, the wiring diagram of which is depicted in Fig. 1. By referring to this figure, it is seen that the supporting and trailing wires of the transmitter

really act as the antenna and counterpoise; the length of these wires (commonly called legs) are so adjusted that, together with the inductance L of the transmitter, an operating wavelength of approximately 125 meters is secured.

This little set, known as the Signal Corps Type BC-164, weighs but 11 ounces; the total weight including the legs and battery being only 17 1/4 ounces. As can be seen (Continued on page 364)

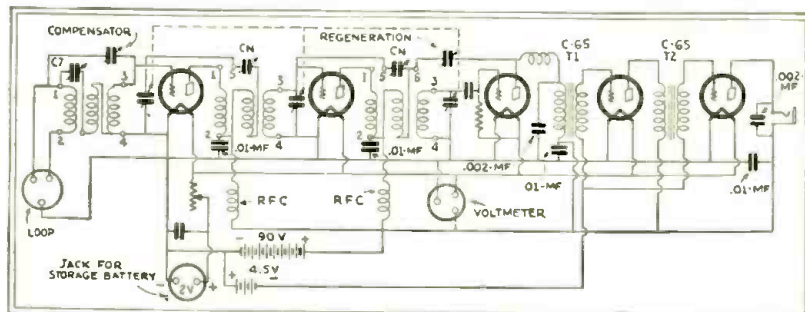

Fig. 4

The schematic diagram of the receiver used with the direction finder. It is a five tube receiver employing two stages of R. F., a detector and two stages of A. F.

Recently, a number of our readers suggested that we burlesque some of our well-known radio set manufacturers' advertisements. The idea of burlesquing national advertisers seems to have taken the

Horrible superiority ZEN-ITCH Tone Tee-Totality



**ZEN-ITCH
MODEL 939 3/8**

Ten-Tube Supper-Heteroecious with genuine Autocratic Tuning and Tone Tee-Totality. A sickly designed tomboy of rare hardwoods . . . complete with Zen-itch Quality tubers, \$1.95 . . . Other new Zen-itch Receivers from 13 cents to two bits.

ZEN-ITCH and science have at last developed the great Tee-totaller Radio. This titanic prohibition radio is ten years ahead over all others. At last you have a set that gives you what you want, when you want it. Dispensing anything from best shellac varnish down to near-beer.

Fully equipped with a static suppressing cocktail shaker, noiseless cuspidor, chromium plated shock absorbing foot rail, free lunch attachment with anti-fading control, variable mu seltzer, automatic electric bottle selector, cocktail shaker equipped with screen grids, autocratic volume control which also dispenses sawdust on 10 kilocycle selectivity. Special long distance liquor tester built right into the set; tests all hard liquor aromatically on short wave lengths. Automatic volume control of set locks up all liquor as soon as guests become too noisy.

NEW 1942 SUPPER-HETEROECIOUS



ZEN-ITCH RADIO CORPORATION, CHICAGO, ILL (very much so) *World's Largest Bakers of High Trade Radio*

*the rare quality that leaves
NO (s)tone unheard*



Hollow music! Something missing! There are notes and tonal beauties you NEVER hear with an ordinary radio. Why cheat yourself of FULL radio enjoyment, when ZEN-ITCH TONE-TOTALITY leaves NOTHING unheard.

This advertisement not paid for. Wish it were, though!

HOTWATER BENT RADIO

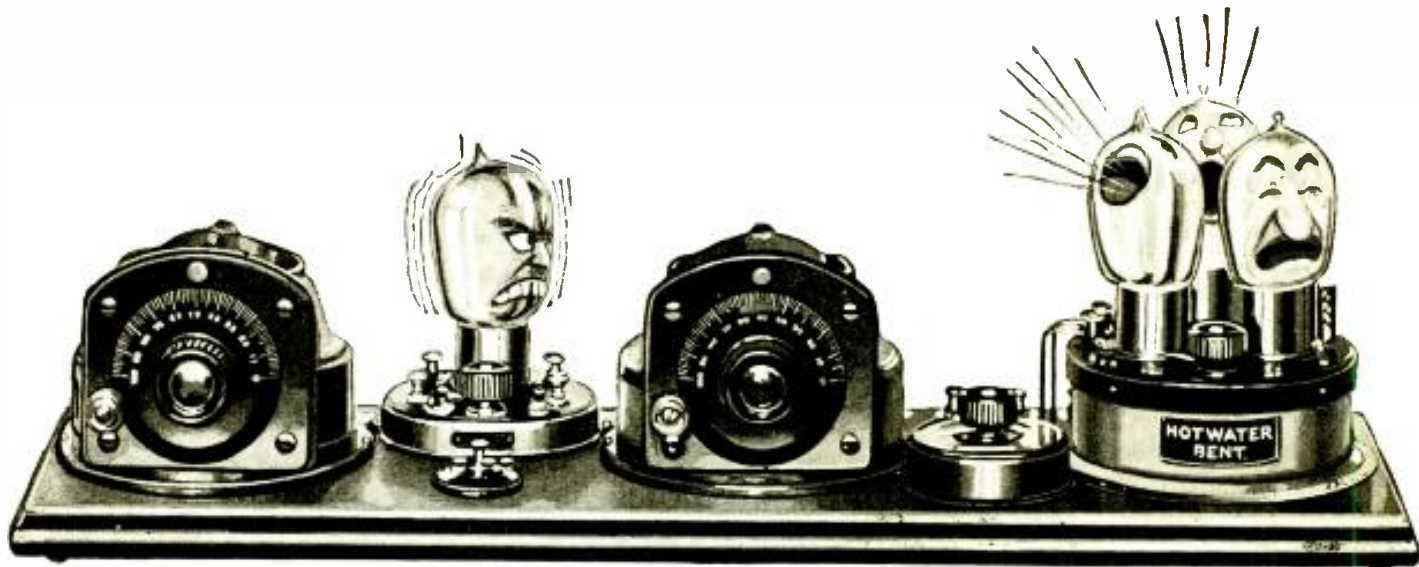

Compact Model 1922B.C.—Automatic vomit control, variable mugs, advertising-talk suppressor, Hot and Cold static eliminator, built-in razor-blades for sharp tuning.

“We wouldn’t trade our Hotwater Bent for any two other radios”

(ANOTHER UNSALTED, SPONDOOLIX TESTIMONIAL)

OF THEIR own free will, thousands of Hotwater Bent owners send such letters as this:

“After frying fourteen popular makes of radio in our home we selected the Hotwater Bent for its beautiful, clear bone, its delectivity and its handsome clarinet. We wouldn’t parade it for any other two radios on the market.”

From Mrs. V. C., Cleveland, Ohio.

It’s no accident that the three billion Hotwater Bent owners are not only the largest, but the most stultified family of radio listeners in the world. The extra valet built into every Hotwater Bent makes them so.

HOTWATER BENT MANUFACTURING CO., PHILATELICS, PA.

GOLDARN VALUES

with the GOLDARN VOICE

Here’s more than slow price—more than snowy performance when new. Here’s intellect of smallest retail—quality that endears.

Look out for VALUE this year as never before. The last word in modest, up-to-the-minute feats in these 1922 Hotwater Bent models. Look for slow prices, too!—but not too slow for safety. Look for a radio you can love with and be snappy with.

Buy VALUE. Buy wistfully. Buy for losing satisfaction. At any Hotwater Bent dealer’s—on general over-payment terms.

Nine New Goldarn Values Models

Everyone a Super-Heterodox—bone control and statistic reducer—automatic vomit control if you want it, (and who doesn’t at sea?) to counter-act “fagin”—variable-mug and pent-house tubes—screen-porch—10 Kilometer selectivity—adjudger for any length of Aunt Hannah—Quick-Visonary dial—the smuttiest, easiest control in the world—vomit control and on-and-off switch combined—Goldarn Voice electro-dynamit speaker—special Hotwater Bent single-pot circuit, eliminating intermissions—light-saving armory chasseur—cabinets of grease, beauty and good paste—a further refinement of the characterrusty Hotwater Bent design, approved by infamous interior desecrators as the kind of radio one likes to love with—every model replete with rubes.

Neither is this one.

NEW Devices

The latest radio equipment is described here for

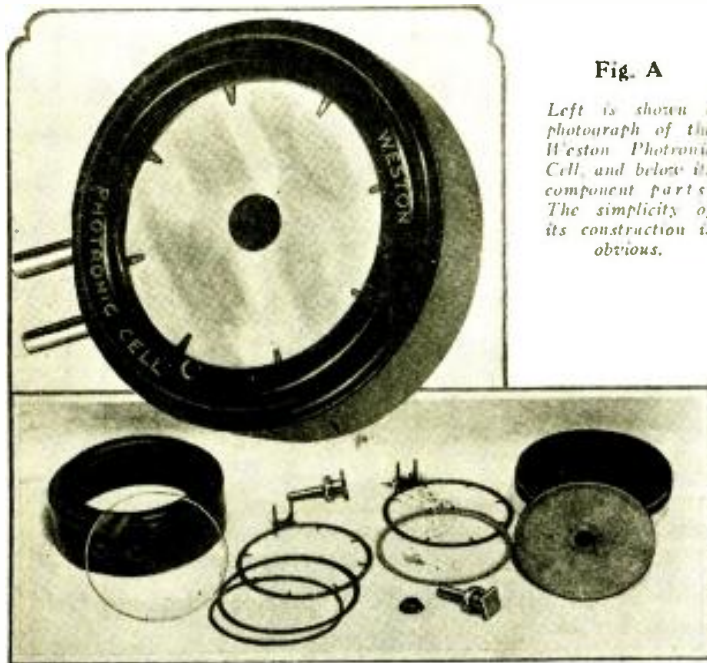

Fig. A

Left is shown a photograph of the Weston Photronic Cell, and below its component parts. The simplicity of its construction is obvious.

CURRENT GENERATING "PE" CELL

By H. G. Cisin, M.E.*

A NEW photo-electric device, the "photronic" cell, illustrated in Fig. A, which is capable of generating sufficient current to operate a sensitive relay, is now available.

There are four main points concerning which the technician exhibits particular interest, as follows: sensitivity to light change, speed of action with respect to light change, methods of operation, and construction. Concerning the last factor there is little information available at the present time; of course, this does not affect the operation of the unit. The other items will be considered; also, other characteristics of this

glass cover-plate, a copper contact-ring (which connects to the "plate" prong of a UX-base connection, the special light-sensitive plate (extreme lower right), a special washer, the second contact-ring and its UX-base "filament" connection-prong, the second black washer, and bakelite case-plug (upper right) which screws into the case and holds together the entire assembly. A tiny plug in the center of the light-sensitive plate spaces it from the glass cover-plate.

Its active element is the specially-treated disc. When light impinges upon it, an electron stream is produced; thus there is a direct transformation of light energy into electrical energy.

As far as is known, the life of the cell is practically unlimited and a continuous current flow does not harm it in any way. Since it does not contain any liquid nor require vacuum or gas, there is nothing to get out of order as it is not subject to physical or chemical change and it has a constant output. It can be exposed to direct sunlight without deterioration, has no dark current since its energy is derived directly and only from light; no drifting, hence no circuit adjustments are necessary; no fatigue; and is non-microphonic. The resistance of the cell varies from 1500 ohms at 10 foot-candles illumination, to 300 ohms at 240 foot-candles intensity.

This device, shown completely assembled in Fig. A, measures over all only 3 x 1 in. thick; and weighs only 3½ ozs.

This new device, manufactured by the Weston Electrical Instrument Co., is known as the Model 594 Photronic Cell. Although simple in construction, each component has received the same attention to precision which has characterized all previous Weston products.

THE MODERN RADIO CABINET

AS evidenced in the Westinghouse "Colunnaire," Philco "Lazyboy," and other late model receivers, radio cabinets are rapidly climbing out of the rut of convention, their design taking a turn which bids fair to establish new standards of comparison in the cabinet-maker's art.

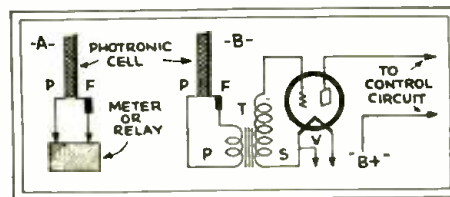

Fig. 2

Two diagrams in which the photronic cell may be used; left, connections for a meter or relay output; at right, loudspeaker operation.

really marvelous instrument, which is destined to come into great prominence.

As illustrated in the graph, Fig. 1, the sensitivity is approximately 80 microamperes per lumen. Preliminary frequency-response tests indicate that the action is so rapid, it probably will be satisfactory for use in talking motion picture and television transmission work; color-sensitivity graphs have not as yet been completed. Connections which may be employed are shown in Fig. 2; at A, the circuit for direct operation of a milliammeter or 5-ma. relay; at B, recommended circuit for indication (on a loud speaker, etc.) where the light intensity changes rapidly. As shown in Fig. A, the utter simplicity of the Photronic cell is striking.

The assembly proceeds in the following order: Into the bakelite shell (extreme left), is dropped one of two black washers, a

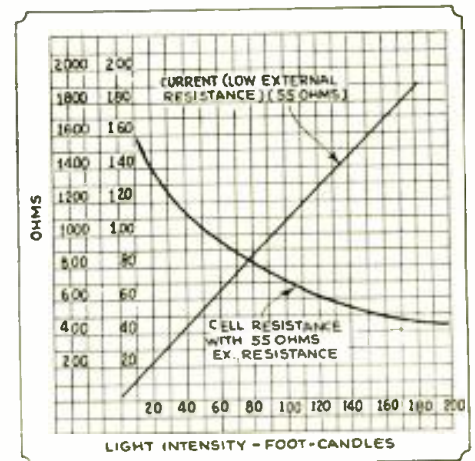

Fig. 1

Response curves of the Weston Photronic Cell. These illustrate the variation of output current and cell resistance as the light intensity changes.

*In collaboration with the inventors, Messrs. C. H. Bartlett and A. H. Lambie of the Weston Electrical Instrument Corp.

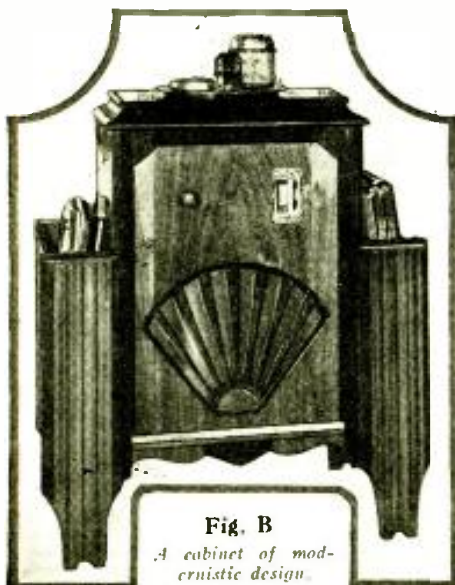

Fig. B

A cabinet of modernistic design.

in RADIO

the trade, Service Man, and home-constructor.

A late cabinet construction available to set builders and owners, which is designed to accommodate any receiver chassis, is illustrated in Fig. B. Note the side panniers for current periodicals, and the "modernistic" lines slightly modified by curves. Another cabinet model is designed to accommodate in its top a standard midget set, cabinet and all; and in lieu of the front panel and speaker-grille shown in Fig. B, there are provided shelves for books.

The same firm, Washington Radio Furniture Co., manufactures other models, including a tall, narrow bookcase design. At the top is a section just large enough for a midget chassis and reproducer; a small door closes this portion of the front. Surmounting the case is a fancy riser which may be cut to fit a small electric or spring clock.

HARMONIC SERVICE OSCILLATOR

RADIO information, like the data in all other fields, is changing every day. For instance, the service oscillator of yesterday, designed to cover the extremely wide frequency range of, say 115 to 1680 kc., would have been a rather bulky instrument incorporating either a tapped coil and range-selecting switch or plug-in coils; either design would necessitate the use of a multi-scale graph.

Modern oscillators, however, may incorporate the principle of harmonic production in vacuum-tube circuits, with consequent reduction of size and increased speed in their use. The theory involved, and a discussion of one commercial instrument of this type, appeared in the July 1931 issue of RADIO-CRAFT. Another "harmonic-type oscillator" of the shielded type is the Acrocycle Oscillator, Fig. C; the schematic circuit is relatively standard, Fig. 3.

This new service instrument has a combination scale and pointer



Fig. D

A group photograph of novel German units. Above, upper left, Fig. D1; upper right, Fig. D2; center left, Fig. D3; lower left, Fig. D4; lower right, Fig. D5.

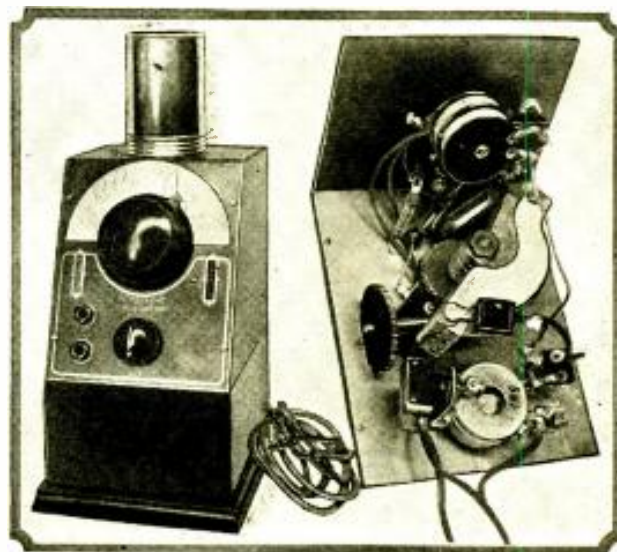

Fig. C

Above, The Acrocycle Harmonic Oscillator. The exterior of the shielded unit is shown at the left; center, the shielded lead; at right, interior arrangement.

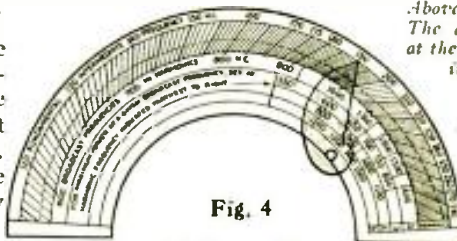

Fig. 4

Left, An enlarged view of the scale used on the harmonic oscillator. Note the curvature of the tuning pointer.

of special design, Fig. 4.

Frequencies are read at the intersections of a red line (shown dotted in Fig. 4); for increased accuracy, a magnifying glass may be used. The celluloid pointer fastens at the periphery of the knob.

Quick shifts in tuning may be made with the large knob; a 68 to 1 ratio vernier is shown at the right. The small knob controls the power output which may be increased sufficiently for neutralizing circuits by pushing the antenna plug (at the end of the twin-conductor, shielded lead) farther into the post marked ANT., until the tip touches connection J, Fig. 3.

Coils L1 and L2 are little 350-turn pancakes 3/8-in. wide, wound with about No. 28 S.C.E. wire on forms 1/2-in. in diameter. Condenser C1 is a trimmer (adjusted and sealed at the factory) in shunt to the 350 mmf. tuning condenser C. Units R1 and SW. are ganged. The batteries required for operation are contained in a separately shielded section in the lower part of the oscillator.

Although the Acrocycle Oscillator is available as an independent, shielded unit, as shown in Figs. 3 and C, the Service Man may prefer to obtain the more complete instrument which includes this oscillator, the required '30 tube, four No. 2 dry cells (for the "A" potential),

(Continued on page 365)

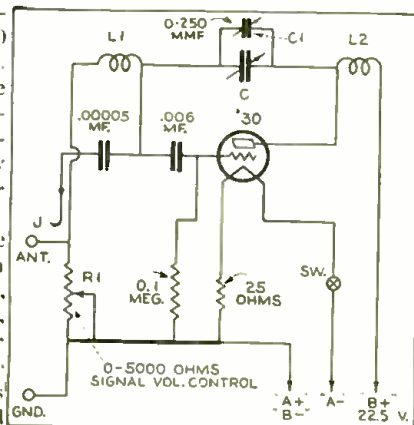

Fig. 3

The diagram of connections of the Acrocycle oscillator.

R. F. Coil Design

Some Notes on Calculating R.F. Coil Resistance

By C. W. PALMER

WHEN the screen-grid type of tube was first introduced to the American market, it was believed that poor selectivity was an inherent part of its action. However, as design engineers became more experienced in its use, it was found that the apparently poor selectivity was due to the greater amplification per stage and to the constants of the parts used in the early sets. Later, band-selectors were employed to give the desired selectivity and constants were used which equalized the amplification over the entire broadcast band.

It is well known that the band-selector causes an appreciable reduction in the R.F. amplification, as well as requiring very careful adjustment; all of which results in an increase in the costs of production. With this point in mind, the writer set out some time ago to find a suitable means for obtaining sufficient selectivity without the use of band-selectors. This was not done with the idea of detracting from the use of such tuning devices, but rather to find a means of reducing the cost of making sets in pro-

duction without sacrificing either amplification or selectivity.

Increasing the R. F. Gain

After some deliberation, it was decided that the most logical point of attack was in the R.F. grid coils. The results obtained by redesigning the coils in several trial sets were so gratifying that it was decided that others might find the information useful. The following notes made at the time deal entirely with the secondary coils. Later, perhaps, we will discuss some changes in the primary coils, especially the primary of the antenna coupler.

The amplification obtainable in an R.F. amplifier depends primarily on the ratio of the inductance to the capacity multiplied by the resistance (of the coil); expressed

$$\frac{L}{C R}$$

mathematically, —, and it is evident that

the greater the inductance compared to the capacity and coil resistance, the greater the amplification that may be realized. As the size of the inductance (L) is limited both by the maximum wavelength to be received,

(Continued on next page)

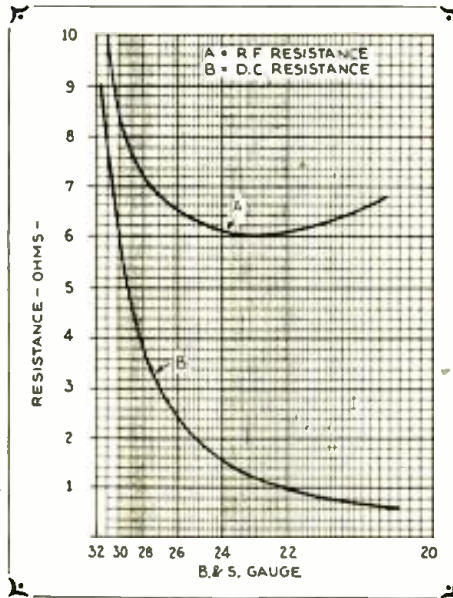

Fig. 1

Note that for the smaller gauge wire the A.C. resistance of a coil may be several times its D.C. resistance.

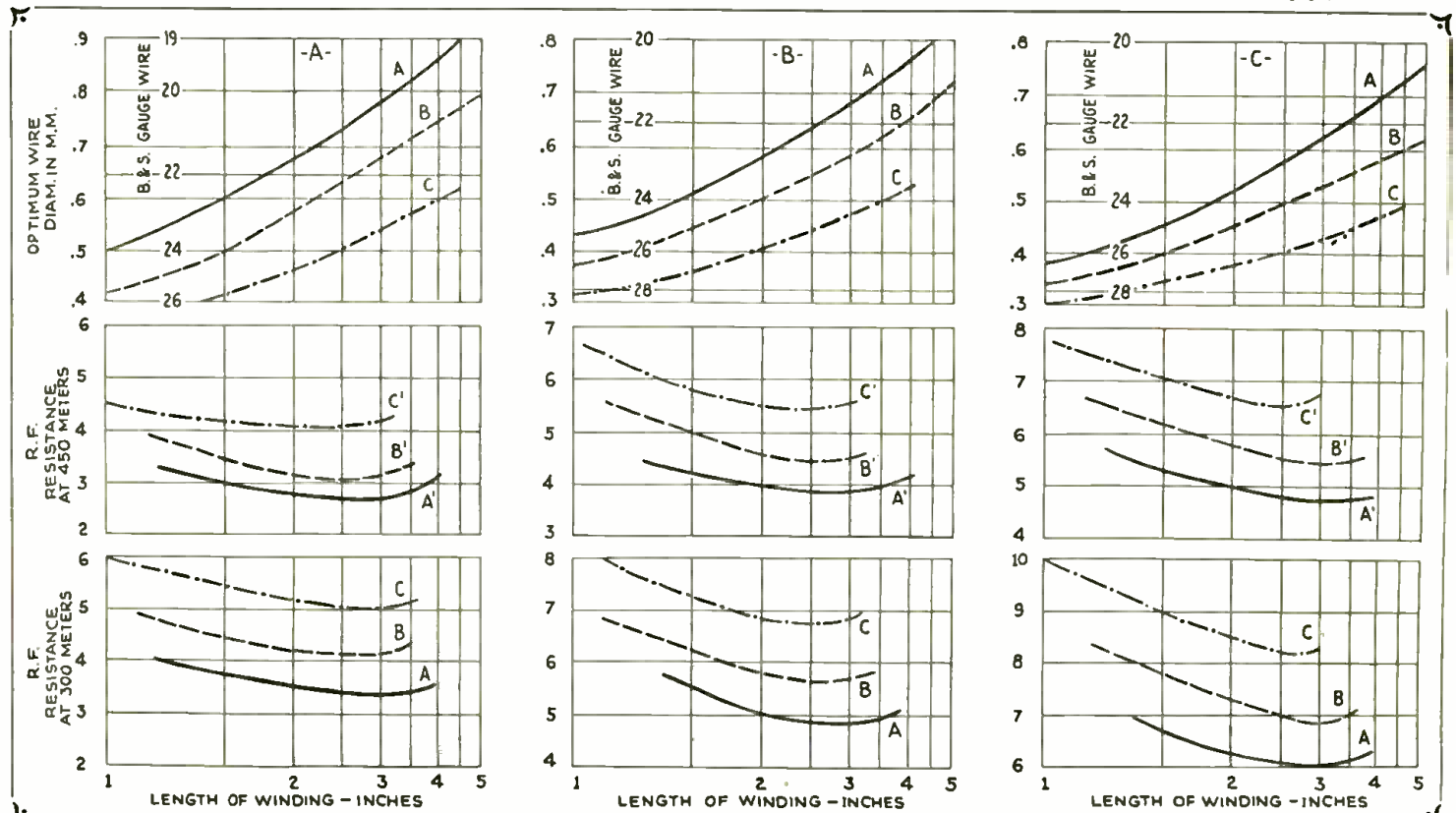

Figure 4, upper row. The curves A, B, and C indicate the optimum size wire for various winding lengths, inductance and coil diameters. Curves A, B, and C are coils 3 ins., 2½ ins., and 2 ins. in diameter, respectively. The three rows A, B, and C are for coils of different lengths; A to be used with .0005-mf. tuning condensers, B with .00035-mf., and C with .00025-mf. condensers.

Figure 5, center. The R.F. resistance of coils of various winding lengths, inductance, and diameters, is shown, taken at 450 meters.

Figure 6, lower. The R.F. resistance of coils of various winding lengths, inductance, and diameters, taken at 300 meters, is illustrated.

The ANTENAPLEX SYSTEM

(PART III)

By E. JAY QUINBY*

THE procedure for installing the Antenaplex system in existing buildings is as simple as wiring these structures for any other purpose,

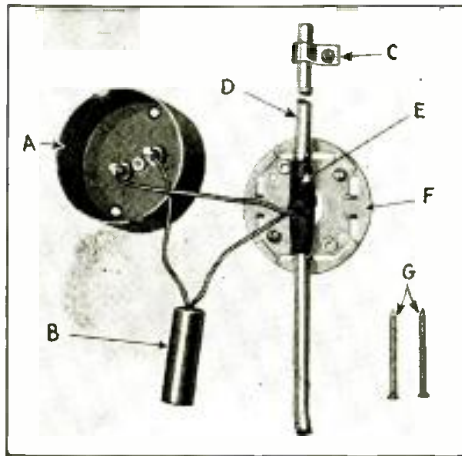

Fig. J

At A is shown the surface box, at B the "taplet," at C the Cabloy clamps, at D the Cabloy, at E the tap to the outlet box, at F the base of the surface box, and at G the mounting screws.

*National Sales Engineer, Centralized Radio, RCA Victor Co., Inc.

such as electric signaling systems, telephones, or electric lights.

The Cabloy, which is a lead covered conductor 5/16" in diameter, may be readily "fished" through hollow partitions, or run "open" along the surface, and where thus exposed, it should be secured at frequent intervals by the cable clamps furnished for this purpose. This little clamp or clip, requires only one screw to attach it to the wall surface, baseboard, or other trim, and is so designed that it provides a suitable anchorage for the Cabloy, without crushing or otherwise injuring the conductor sheath or insulation.

For such cases, and for cases where exposed or surface wiring is employed, a special circular surface box has been developed, Fig. I, which has many advantages over the usual rectangular surface box. First, the round cover presents no sharp corners to catch or interfere with objects ordinarily moved back and forth past its surface; second, it is universal in its application for horizontal and vertical runs, and will also accommodate locations where it is desired to transfer from a horizontal to a vertical run; third, it will adapt itself to locations where it is desired to effect transition from

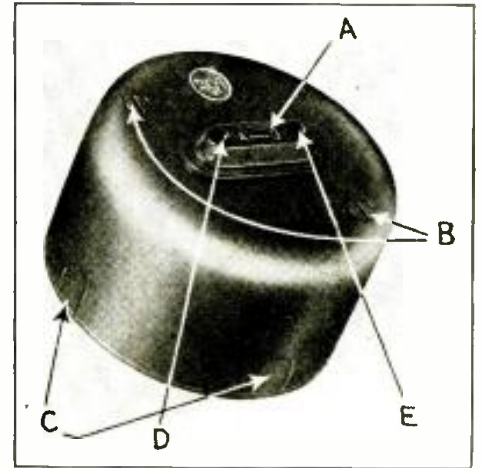

Fig. I

At A is shown the mounting strip, at B the mounting screws, at C the clamping ears, and at D and E the antenna and ground posts.

concealed to surface wiring; fourth, its base is provided with clamping ears which not only secure the ends of the Cabloy in place, but also effect the necessary bonding nating current voltmeters and ammeters.

(Continued on page 367)

R. F. COIL DESIGN

(Continued from page 338)

and the size of the tuning condenser (C), it can be readily seen that reduction of the coil resistance (R) must result in an increase in the amplification. Thus it will be found that to cover the broadcast band, 340 millihenries is the maximum permissible inductance that may be used with a .00025-mf. tuning condenser; and even then, either very loose coupling (between primary and

secondary), or an antenna series condenser, is needed to tune below 250 meters,—because of the effect of the capacity of the antenna.

If the coil resistance (R) in the above ratio was the direct current resistance of the coil it would be a simple matter to reduce it merely by increasing the size of the wire. But Fig. 1 shows that there is a point beyond which the radio frequency resistance increases with a further increase in the wire size. The curves in this figure were made from data obtained with a coil of 74 turns of No. 24 wire, wound on a form 3 inches in diameter and 2 1/4 inches long.

Finding R.F. Resistance

The R.F. resistance was calculated from Butterworth's formula:

$$R_1 = R \left\{ 1 + F + G \left(\frac{Kn d}{2D} \right)^2 \right\}$$

in which R₁ is the R.F. resistance of the coil, in ohms; R, the D.C. resistance of the winding, also in ohms; n, the total number of turns; and d, the diameter of the wire in the same units as D, the diameter of the coil. Both F and G are factors proportional to:

$$Z = \frac{d \sqrt{f}}{92.8}$$

where f is the frequency at which the coil is to be used and d, the diameter of the wire in millimeters. K is the shape factor, which depends upon the length and diameter

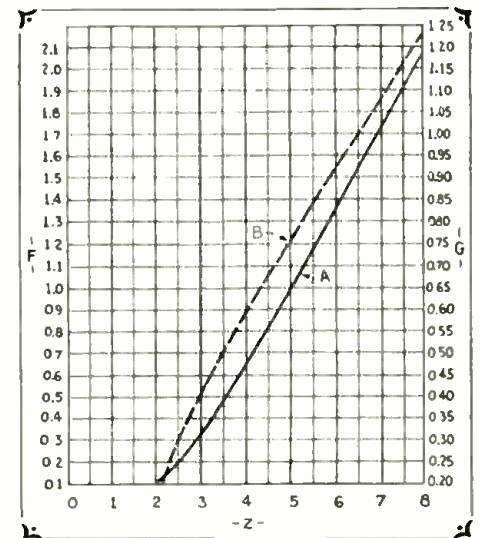

Fig. 2

The values of F and G corresponding to curves A and B may be determined from this graph. of the winding. The values of F, G, and K are shown graphically in Figs. 2A, 2B, and 3, respectively.

As an illustration of the procedure used in calculating the R.F. resistance of a coil, the example cited above may be used.

The wire is .565-millimeter in diameter (determined from a wire table); and a wavelength of 300 meters (1,000,000 cycles) will be used. The D.C. resistance of the wire is .0214-ohm per foot. The linear

(Continued on page 366)

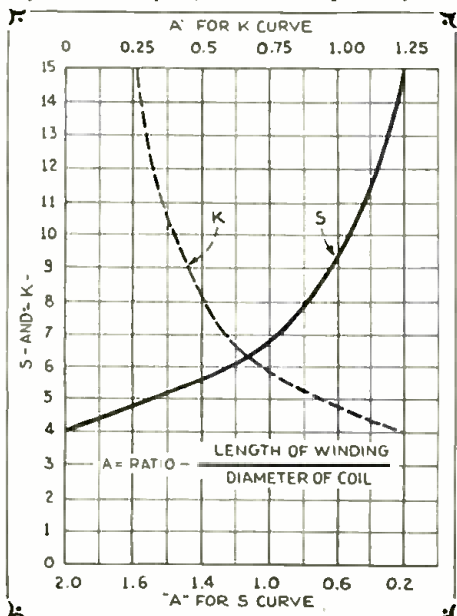

Fig. 3

The values of K and S used in the calculations may be taken directly from the curves.

SPEECH *Input Equipment*

(PART V)

By ELI M. LURIE, B.E.E.

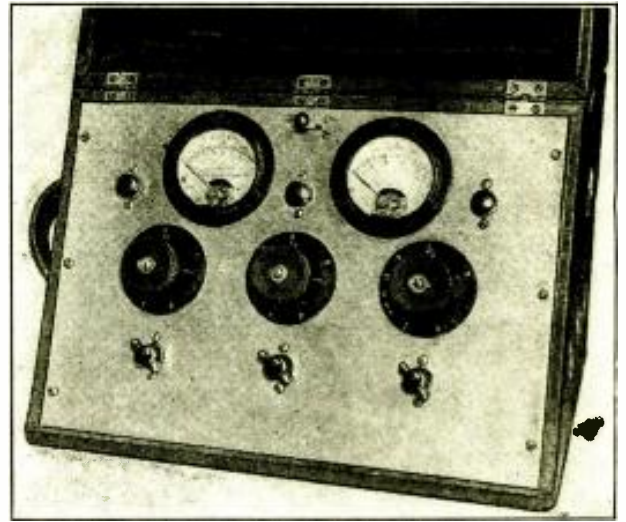

Fig. A

Front view of the condenser microphone mixer used at the Hotel New Yorker.

IN previous articles the main radio and remote controlled public address apparatus in the Hotel New Yorker were described and illustrated. Copies of the issues containing these stories are available.

Every commercial public address or broadcast installation uses a speech amplifier. This amplifier is usually located directly after the microphone and all speech that enters the main amplifiers must first pass through the speech amplifier. Thus it can be easily understood why the speech amplifier plays such an important role. But aside from this, the amplifier must also do the following:

- 1st. The applied input must be amplified sufficiently so that enough output voltage will be available to feed the power amplifiers.
- 2nd. The amplifier must produce distortionless amplification.
- 3rd. Its input and output impedance must match the apparatus into which it is worked and being worked.

These are the most important conditions to be considered in the design.

In some cases the speech amplifier plays

the dual role of both speech and radio set amplifier, as in this hotel public address system.

The question of battery operation is also very important. Most large installations use batteries for this amplifier and also for microphone button current as the possibility of hum is very great. However, in the New Yorker, the speech amplifiers are completely A.C. operated, and yet the hum level is only -50 DB.

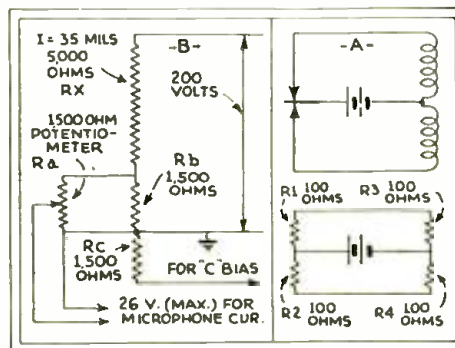

Fig. 2

At A, mathematical equivalent of microphone connections. At B, the circuit connections of the drop-wire resistor.

The design of the amplifier proper for A.C. operation is not very difficult, but the method of obtaining the microphone current from A.C. is apt to be perplexing.

Where it is necessary that button current readings be carefully read and logged it is, of course, desirable to eliminate the "click" when the milliammeter is inserted into the microphone circuit. It is also desirable to incorporate a method whereby the gain may be raised to a very high level for emergency use, but under normal conditions the gain may be reduced to regular operating values.

Circuit of Speech Amplifier

In Fig. 1 is shown the schematic circuit of the high-quality speech amplifier used in conjunction with the guest room apparatus.

As the main amplifiers are designed to operate at the radio receiver output level, the speech amplifier should be designed accordingly for normal operation with an output level equal to that of the radio receivers. (However, as the output of a good radio frequency amplifier and linear power detector is quite high, it is necessary to use at least a single stage of audio frequency after a carbon microphone if the level is to approximate that of the detector unit).

There will be times when the pick-up from the microphone will be feeble and for such occasions the use of an additional '27 stage will be of advantage. This extra stage is connected into the amplifier circuit merely by operating the toggle switch X. The switch connects the primary of the line output transformer either to the plate of the first or second A.F. tube as shown in Fig. 1. By using this arrangement sufficient amplification can be obtained to load the power amplifiers to a maximum condition.

Correct impedance matching has continually been stressed as most important where excellent quality is desired. For this reason the output of the microphone transformer matches the grid-to-filament impedance of a type '27 tube. Likewise the primary of the output transformer is matched to the plate impedance of the same tube. The secondary of the line output transformer is 500 ohms to match the input line of the

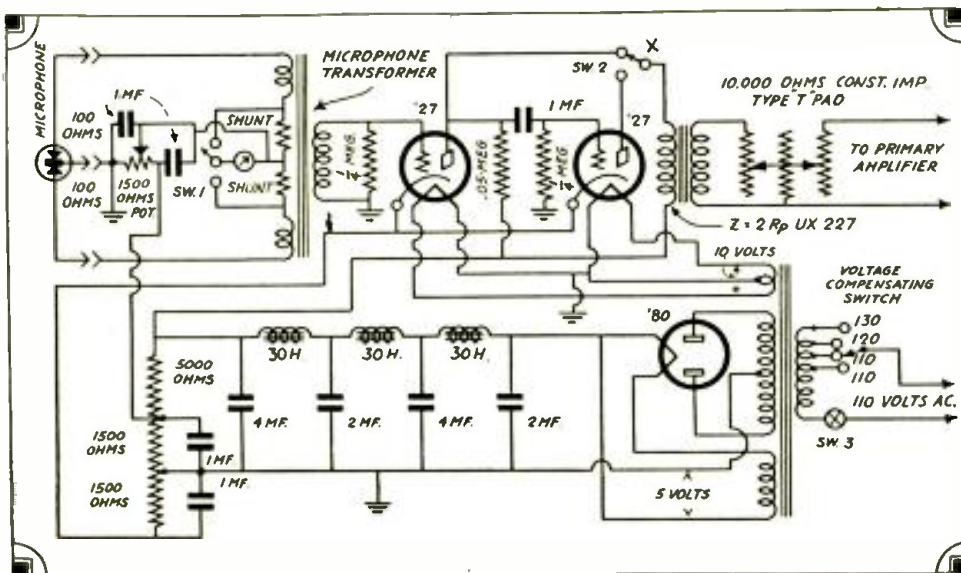

Fig. 1

Diagram of connections of the high-quality speech amplifier used in the Hotel New Yorker sound installation.

primary amplifier in the main amplifier rack.

It will be observed that resistance coupling is used in the second stage. Resistance coupling will usually produce even amplification and is also good in that the resulting gain can equal no more than that of the input voltage, times the amplification factor of the tube. Distortion is therefore limited in the amplifier to a very low value and can be considered almost negligible.

However, where resistance coupling is used difficulties arise due to the characteristic low frequency oscillation ("motor-boating") occurring in this type of amplifier. To eliminate any possibility of such oscillation an extra filter section consisting of a 30 henry choke and 4 mf. condenser is added to the regular filter circuit. In addition, the plate supply is steadied by a low resistance drop-wire of 5750 ohms.

Of most interest is the method used to obtain microphone button current. In Fig. 2A is the equivalent microphone circuit. As the microphone transformer is designed to match the impedance of the microphone, its split primary will have an impedance of 100 ohms on each side. Each button will, therefore, be in series with 100 ohms making a total of 200 ohms on each side of the button battery. The Western Electric standard broadcast microphone (type 387) is usually operated at about 20 milliamperes per button. Therefore, it follows that to supply this current our battery must have a potential of 4 volts or $E = 4 = (.02)(200)$. Also as we have two sides to supply, the total wattage will be

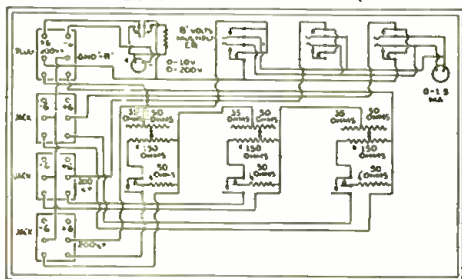

Fig. 5

Schematic circuit of the condenser microphone mixer illustrated in Fig. 4.

$$W = EI \times 2 = 4 \times (.020) (2) = .16\text{-watt necessary.}$$

In Fig. 2B is the circuit of the drop-wire resistor. The output voltage is 200 volts and as the "bleeder" current will determine any voltage drop across the drop-wire, it is well to consider this item first. The variable 1500 ohm potentiometer R_a is used to supply the microphone with its E.M.F. This potentiometer is in parallel with a 1500 ohm resistor R_b . The bleeder current will, therefore, divide between the two resistors. The total resistance of these two parallel resistors will be 750 ohms. This added to the 5000 ohm resistor R_x makes a total of 5750 ohms as the whole drop-wire resistance. Our "bleeder" current will, therefore, be $I = \frac{200}{5750} = 35 \text{ ma.}$

As the bleeder current divides between the two 1500 ohm resistors each resistor will have approximately $\frac{35}{2}$ or 17.5 milliamperes passing through it.

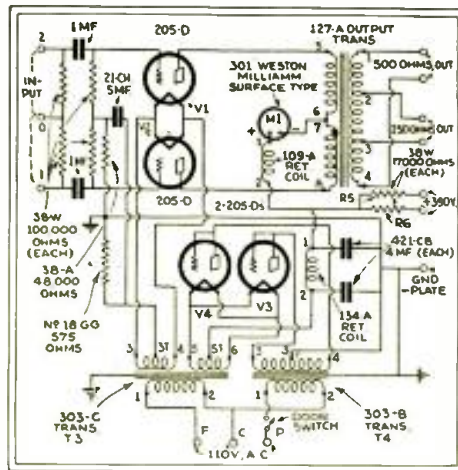

Fig. 4

Schematic circuit of the power amplifier design for hotel use.

Thus the voltage across R_a will be $1500 \times .0175 = 26+$ volts, and the wattage dissipated by this resistor will be 0.45-watt. The microphone circuit resistance will, however, be connected in parallel with some section of R_a and this must therefore be considered. As the microphone wattage has previously been calculated as .16-watt, the rating of R_a must be equal to $.16 + .45 = .61\text{-watt}$. A two-watt, 1500 ohm potentiometer should be satisfactory and can be used in this position.

It is true that the microphone circuit will be connected across only a small portion of R_a but every calculation should always be made for the extreme case. Thus R_a can supply a maximum potential of 26 volts, but as only about four volts are required for a single microphone the slider will generally be across only a small portion of the resistor. The idea of having as much as 26 volts available is for use in case several microphones are to be used. (With such a condition each microphone will generally have its own matching transformer.)

Every one who has had any experience with carbon microphones knows the difficulty of eliminating clicks when taking microphone current readings. The usual procedure when reading button current is to insert a milliammeter, first into the circuit of one of the buttons, and then, after the

reading is obtained, the milliammeter is inserted in the other button circuit. In each case, the circuit is broken as the meter is cut into and out of each circuit which produces a decided and loud click. To eliminate this interference, engineers devised many different schemes. One makes use of relays that open the microphone circuit to the milliammeter only after the meter has been inserted, thus eliminating clicks. Of course such a method could be used with excellent results, but the cost offsets the advantage. Another system makes use of various filter arrangements which are connected across the jack into which the meter is plugged, but, with this method, there is almost always a small resulting click that at times is extremely disagreeable.

Perhaps the easiest and yet possibly the best solution of the above problem is to use a low reading milliammeter with two shunts. Any 0-1 up to a 0-5 milliammeter may be used. The shunts may be made out of heavy resistor wire of about number 12 gauge; they are connected as shown in Fig. 1. The shunts may be designed to carry

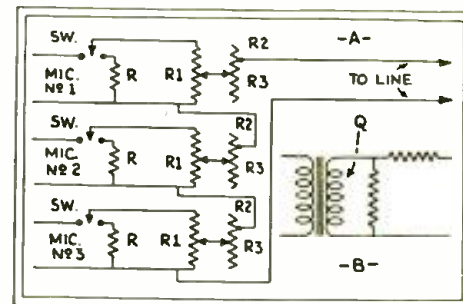

Fig. 6

At A, this circuit shows the manner in which constant impedance is obtained in the microphone "attenuator circuit." At B, theoretical figure of reference.

10 to 15 times the current passing through the meter. The scale on the meter is calibrated to read directly the total current through each button as the double throw switch SW. 1 is placed across either shunt. Supposing the meter is a 0-5 milliammeter, then the scale is changed to read from 0-50 milliamperes.

Of course the ohmic values of the shunts depend upon the internal resistance of the (Continued on page 368)

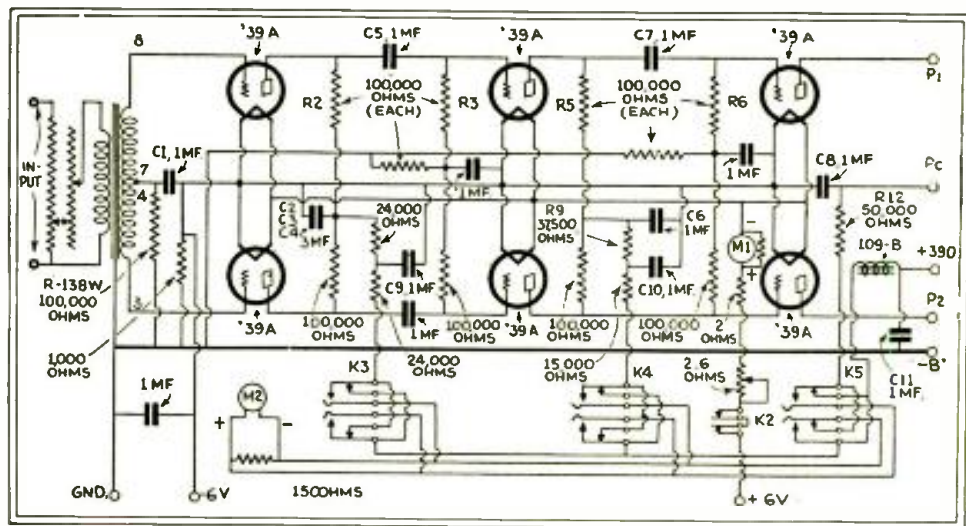

Fig. 3

Redesigned W.E. 41A speech amplifier circuit. Direct current must be used on the filaments. This current is most conveniently obtained from dry-rectifier-type "A" units.

Magic in Meters

(PART II)

In this second of a series of articles, Mr. Denton describes the various types of A. C. meters used in radio work.



A practical application of a copper-oxide meter.

IN the first part of this series which appeared in the November issue of RADIO-CRAFT, the historical development of the D.C. voltmeter and ammeter was discussed, starting from the original tangent galvanometer.

The "instrument problem" received much attention from such distinguished minds as Deprez and D'Arsonval in France, Kelvin, Perry and Ayrton in England, Siemens and Hummel in Germany, and many others of equal fame, in the time succeeding Oersted's and Schweiggers' crude devices.

Dr. Weston, in the United States, after many years of strenuous effort developed the first permanent magnet pivoted moving coil type of instrument. This development of Dr. Weston revolutionized meter design, and placed the art of electrical measurement on a new plane.

In the determination of the effectiveness of an alternating current, the square root of the average squares of all the instantaneous values of alternating current is taken, and expressed in units of a given direct current which will produce the same power or heating effect as the given alternating current. The value so determined is called the effective or R.M.S. value, and is .707 of the maximum value.

Instruments used for alternating current measurements indicate directly in "R.M.S." or effective values (the direct current equivalents) making the computation of these values unnecessary.

Under these conditions we see that the maximum voltage per alternation in a commercial 110 volt A.C. circuit is 155 volts on each half of the cycle.

Iron Vane Instrument

The most common type of instrument for alternating current measurements is known

as the iron vane type. This class of meter can be found in most set analyzers and is generally recognized as the most practical for low frequencies.

By CLIFFORD E. DENTON

Referring to Fig. 1A, we see that there are two bars or vanes of soft iron hung vertically in the center of a coil. If no current is applied to the coil, there will be no movement as shown. When a direct or alternating current is passed through the coil as indicated in Fig. 1B, the bars repel each other. Regardless of the direction of current flow, the upper end of the two pole pieces are magnetized either N or S, depending upon the direction of current flow, and the lower ends either S or N. Following the law that like poles repel, we find that the bars are thrust apart.

The commercial models have one of the vanes fixed in position in the coil and the other vane free to move on a pivot, the indicating pointer being fastened to the moving vane to facilitate movement over a scale as indicated in Fig. 1C. It will be noted that the movable pole piece can be displaced only by rotation caused by the repulsion.

the case in direct current meters: the force which causes

the movements of the iron vane depends on the strength of the magnetic field set up in the coil, and the field strength of the coil depends upon the amount of current flowing in the winding. When the current flows through the coil, the movable iron vane rotates to such a position that the opposing force exerted by the spring and the magnetic force of repulsion become equal. The indicator then stops and shows the scale value of the current flowing in the circuit.

In the alternating current voltmeter, the field coil consists of a fairly large number of turns of comparatively fine wire. As it is impossible to wind a coil with sufficient resistance to prevent a flow of current which would damage the winding, a resistance is placed in the circuit so that the current flowing through the coil is reduced to a satisfactory value.

Ammeters have coils wound with comparatively heavy wire. The size of the wire depend on the current ranges of the meter.

Shunts for use with alternating current ammeters are not recommended, especially when the instrument is being used on more than one frequency. If the meter has been calibrated at one frequency and is to be used on another, it should be re-calibrated so as to compensate for any error caused by the shunts.

Multipliers for extending the voltage range of alternating current voltmeters are satisfactory as long as the resistors used maintain their ohmic value.

Figures 2 and 3 show the electrical circuits of alternating current voltmeters and ammeters.

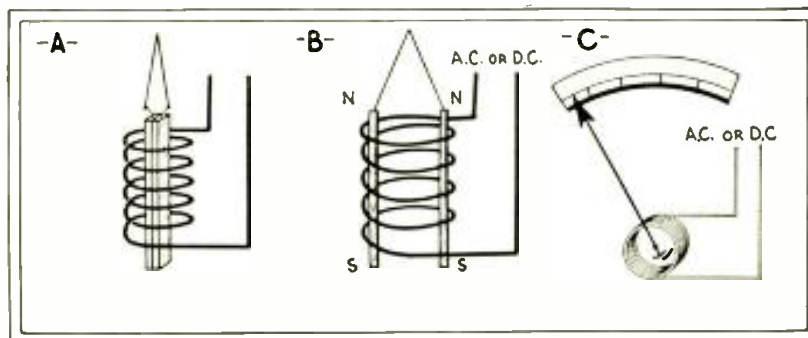

Fig. 1

The principle of operation of the iron-vane movement used in A.C. meters is shown above.

The rotation of this pole piece is opposed by springs which do not carry current as is

The Solenoidal Meter

An instrument that employs a very simple movement is known as the "solenoidal meter." Referring to Fig. 4, we see that it consists of a coil with a plunger C fastened to the indicating arm B. This arm is pivoted at point P so that the plunger can move freely into the coil as indicated.

Current flowing through the comparatively low resistance coil "sucks" up the soft iron plunger, causing the indicator to move over the scale which can be calibrated by sending known values of current through the coil. A weight W controls the action of the plunger and the damping of the indicating pointer is accomplished by the eddy currents in the plunger. This type of movement is inaccurate, due to the large errors caused by hysteresis losses which are traceable to the excessive mass of the moving parts.

This movement will be found only in the less costly instruments.

Hot-Wire and Thermocouple Types

High frequency alternating current measurements are generally based on the heating effects caused by passing a current through a strip of metal. Hot-wire meters depend for their action on the expansion of a metal wire when heated, the wire generally used for the heater being platinum. The latter type of A. C. meter is used extensively for high frequency measurements, but it uses a considerable amount of power, is easy to burn out, and is not permanent in calibration.

The wire AB, Fig. 5 is selected for its ability to expand when it is heated by the high frequency current, and is connected to the circuit in such a manner that the current to be measured will flow through it. The spring S tends to hold the wire AB taut through throat C. The resultant motion caused by the expansion of the wire causes the pointer P, which is rigidly attached to roller R, to move over the scale. The movement of the pointer depends upon the amount of current flowing through the wire.

In the case of the thermal ammeter, we find that the voltage generated at the junction K of the two dissimilar metals CD, Fig. 6, in contact with the wire AB, is impressed across the direct current millivoltmeter M.

The heat in wire AB is generated because of the A.C. energy flowing through the circuit, and is equal to that which would be generated for a certain number of amperes of direct current. The deflection of the needle indicates the *effective value* of A.C. energy as do the iron vane and solenoidal meters.

The thermal junction generally used is made up of the metals copper and constantan, and is heated by a fine wire through

which the current flows. To increase the sensitivity, the junction is generally mounted in a small glass bulb.

The voltage developed by the thermocouple is directly proportional to the temperature, and the temperature of the heated wire is proportional to the square of the alternating current flowing in the heater; the reading of the meter then, is proportional to the *square* of the current through the heater wire. This meter is sometimes called a "current-squared" meter.

Since a D.C. meter reads *average* values, the scale of this meter may be marked so as to read the *square root* of the average value, which as we have seen before, is the effective value of the A.C.

Copper-Oxide Meters

With the development of the modern radio set, a demand for sensitive voltmeters of low power consumption was created. Direct current movements which can satisfy these requirements can be readily built with a sensitivity of 1000 ohms per volt. This means that a current of one milliamperes is sufficient for a full scale deflection. This may be done by simply rectifying the A.C. voltage to be measured and applying it to the D.C. meter.

There are several methods whereby we can rectify the alternating current to be measured. The first is by the use of a crystal rectifier, Fig. 7. The crystal, however, is generally too unstable in operation and needs to be adjusted quite often, and is also subject to burn-out at comparatively low current values. The second is by the use of a tube rectifier, the circuit of which is shown in Fig. 8. The ordinary design of such a device generally limits its application because it is subject to tube failure, and every time the tube needs to be replaced, the instrument must be re-calibrated. The same instrument is sometimes used as an output meter, when the indications are for comparison only.

The third and most desirable method of rectification is by the use of the copper oxide rectifier, Fig. 9. This type is satisfactory from the standpoint of ruggedness, sensitivity, and constancy. Its main disadvantage is that the meter indicates "average" values instead of effective values.

This introduces an inaccuracy in readings which becomes apparent when the voltage to be measured has a distorted wave form. Fig. 10 shows a graph representing a distorted sine wave which would cause an error of about two per-cent. In most cases, however, such small inaccuracies are of but little importance to the Service Man.

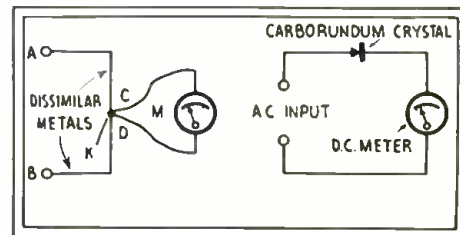

Figure 6 left. The thermo-junction at K generates a D.C. voltage which is applied to M.

Figure 7 right. Observe that the crystal rectifier is used to rectify the A.C. voltage to be measured.

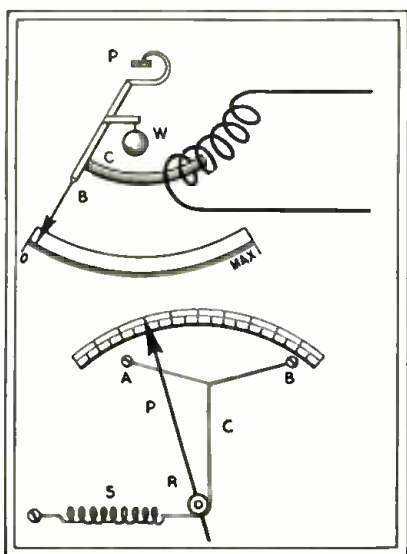

Figure 4 above. The magnetic field generated by the coil "sucks" up the plunger C, moving the pointer B over the scale.

Figure 5 below. The expansion of the wire AB causes the pointer to move over the scale.

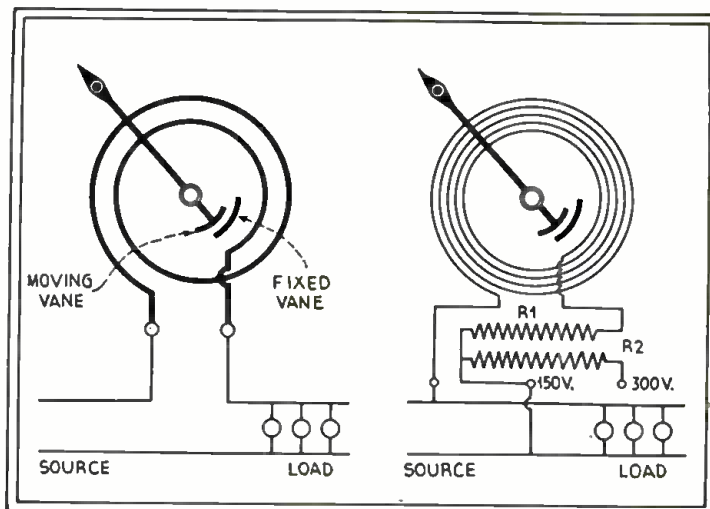

Figure 2 left. Illustration of the mode of connection of the moving vane type of A.C. ammeter.

Figure 3 right. Connections of the multipliers in the moving-vane type of A.C. voltmeter.

An Electrolytic-Condenser-Rectifier

A Novel Power Pack Design Including Only a Transformer and Electrolytic Condenser

By P. M. JAROWEY

THE almost universal use of tubes, of one form or another, for rectifying alternating current to obtain a pulsating direct current, and the subsequent use of condensers and chokes for obtaining a somewhat constant output, has so standardized the radio power unit that rectification and filtration without the use of them does not seem to have been given much thought.

While conducting some experiments last Autumn, the idea of using electrolytic condensers for both rectification and filtration occurred to me, and I am passing it along in the hopes that it may find a place in the laboratory of some experimenter.

Figure 1 is a schematic diagram of the entire arrangement. As can be readily seen, it consists of the conventional power transformer and an electrolytic condenser. This condenser (a double unit is shown although two single ones with their negative terminals connected together may be used with the same results) acts as both the rectifier and the filter. The results obtained with this arrangement have been far better than those obtained by using the vacuum tube rectifier and its associated filter.

Theory of Operation
An electrolytic condenser, like any other condenser, must consist of two conducting

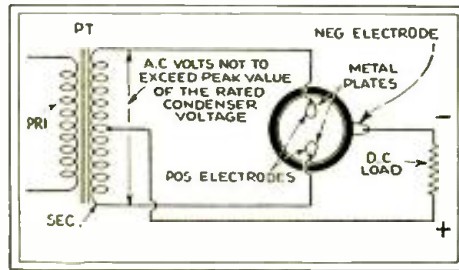

Fig. 1
A simple power pack. The electrolytic condenser design limits the output.

plates separated by a dielectric. The greater the area of the plates and the smaller the distance between them, the greater the capacity of the condenser. If the dielectric is other than air, the capacity is usually greater than if air were used. The dielectric must not be too thin, because if it is, then the voltage that can be impressed across it without puncturing is very small. Thus it is seen that the design of a condenser must

be a function of its capacity, size, and operating voltage.

In the electrolytic condenser, a large metal conductor, coiled so as to minimize space, is used as one plate, and a solution of borax and water for the other plate. When the unit is connected across a properly poled source of D.C. (positive to the metal plate, and negative to the solution, the latter contact being made via the metal container) a film of hydroxide gas is formed on the metal plate of the condenser. This film of gas, only a few atoms thick, is the dielectric. The large area of the plates and the exceedingly small thickness of the dielectric account for the relatively high capacity of the unit.

Now, an analysis of the action of an electrolytic condenser will reveal that current will pass freely and continuously from the electrolyte to the metal plate when the electrolyte is positive with respect to the metal plate, but current will not flow in the reverse direction when the polarity of the applied voltage is reversed. It is this characteristic of the condenser that enables it to be used as a rectifier.

(Continued on page 369)

Magic in Meters *(Continued from page 343)*

standard milliammeter in conjunction with a copper-oxide rectifier. Figure 12 indicates an arrangement which gives accurate indications in A.C. and D.C. circuits, the maximum ranges being limited only by the desires of the constructor. In this circuit a Weston 301 universal meter is used and is provided with a double scale. The upper scale is used when the instrument is connected for alternating current measurements and has a range from 0-5 volts, and the lower is the D.C. scale and is also calibrated from 0-5 volts. The sensitivity of both the A.C. and D.C. scales is 1000 ohms per volt. The meter has four external connections

and a shunt which is calibrated for the meter. The alternating current ranges are thus 5 volts and 1 milliampere and the direct current ranges are 50 millivolts and 1 ampere. Thus by the selection of the proper values of multipliers and shunts the instrument can be used to measure D.C. and A.C. voltages and currents. The voltage and current ranges indicated in the diagram cover most of the requirements of the Service Man. The material required to construct the instrument consists of the 301 universal meter, a double throw

switch, a four contact switch, the panel for mounting the parts, and the necessary binding posts or connectors for the various ranges. The number of resistors necessary for the multipliers and shunts depends on the ranges to be covered. The efficiency of this kind depends upon the accuracy of the resistors used. The builder should not attempt to use resist-

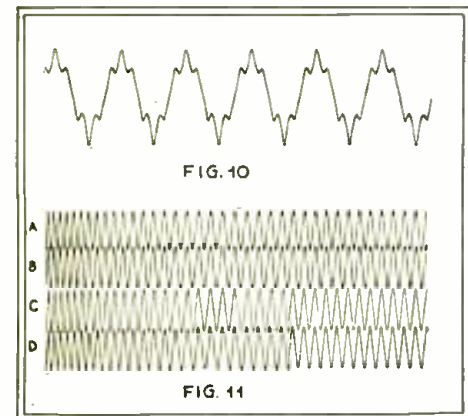

Figure 10 above. An illustration of a distorted sine wave.
Figure 11 below. At A and B is shown the wave form of the unrectified filament voltage in a commercial receiver, and at C and D the unrectified plate voltage. Note that they are all pure sine waves.

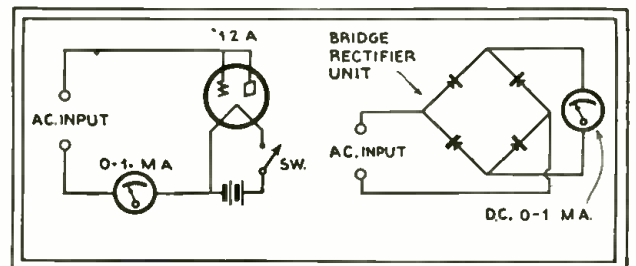

Figure 8 left. The use of the vacuum tube as a rectifier used for measuring A.C. voltages.
Figure 9 right. A bridge connection of dry-disc rectifiers may be used for measuring alternating voltages with a D.C. meter.

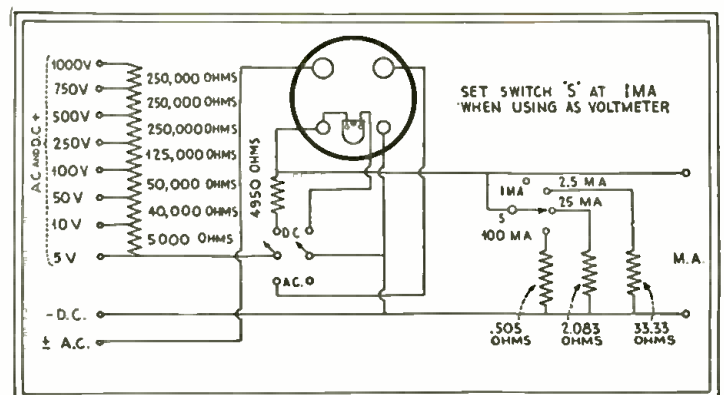

Fig. 12
Complete circuit diagram illustrating how a D.C. meter may be used as an A.C. voltmeter, and both as a D.C. voltmeter and ammeter

The Service Man's Forum

Where His Findings May Benefit Other Radio Technicians

THE SMALL-TOWN SERVICE MAN Editor, RADIO-CRAFT:

I am an independent Service Man in a town of 14,000 inhabitants. I have worked for a dealer, but in view of the small remuneration received, I went in business for myself. I advertise in the two newspapers here, pass out cards from door to door, but business is very slow, although I have been in business for myself only two months. Most of the work that I get is the result of recommendations from satisfied customers.

I have read letters in the "Open Forum" from Service Men in the larger cities who seem to be successful, but I never hear from anyone from a town the size of this, who has much to say.

I would like to have you publish this letter, and would also like to hear from Service Men in the smaller towns who are successful, that is, men who are in *my own class* as regards population.

I belong to the *Official Radio Service Men's Association* and think that every live honest-to-goodness Service Man should join.

RALPH J. WITTER,
Route No. 2, Fremont, Ohio.

AN A. K. BOOSTER

Editor, RADIO-CRAFT:

I wish to answer to the article submitted by Julius Denna in the Open Forum column in your September issue of RADIO-CRAFT.

He complains of being unable to receive service data regarding Atwater Kent Radio sets from his local distributor. I wish to state that a great deal of credit is due to the Atwater Kent Manufacturing Company

for having, without a doubt, the most up-to-date service manual I have in my possession.

It readily helps to locate and correct any condition which might interfere with the proper functioning of the receiver. This valuable manual is offered to any Service Man who can prove his qualifications by simply writing for a copy on his business stationery.

Expert Radio Service

We repair all makes, Battery or Electric
Cunningham and Sparta Tubes delivered Free
Authorized Silver Marshall Service

Only Complete Radio Service in Fremont

Member of the Official Radio Servicemen's Ass'n.

**Place this card in your radio
for future reference**

When in need of immediate service call
main-2515
and save money.

R. J. Witter's Radio Service
Fremont, Ohio

A Service Man capitalizes his association membership. Lettering is black on brown; the card measures 3 1/2 x 5 1/2 in.

I hope the time will come when other Radio Manufacturing Companies will follow the example set by the Atwater Kent Manufacturing Company, and publish data which will be as helpful in servicing their receivers.

JACK LEVINE,
137 Front Street, Worcester, Mass.

"KILLING" SERVICE CALLS

By Henry H. Klappert

AFTER five years of customers' service experience, I have come to the conclusion that 50% of future service calls can be killed at the time of installation by the simple expedient of doing the job right. By this, I mean making a test of the filament voltage and recommending to the customer the use of a line resistor if necessary. Most of them will buy one of these devices on the installer's say so. If the filament is held down to 2.4 volts, on 2.5-volt tubes, little trouble will be experienced for over a year. They should also be tested at this time for loose elements and current output. On tapping the tube when in the socket, loose elements will generally show up; and such tubes should be changed immediately. So much for the set.

When the antenna and ground are installed, the installer should remember that a Service Man might some time be on that job checking for trouble and will probably have to disconnect at various points along the aerial and ground system. Nothing is more annoying than to have to pull out a number of tacks to do this. A first-class installer takes into consideration, not only neatness and electrical efficiency of the job, but also that that set might have to be serviced. A good installation should be made as follows:

Leave about six (6) feet of wire, from the antenna and ground binding posts of the set to the point where the leads are tacked to the baseboards; so that when the set is moved away from the wall these wires will not pull off. They should be tacked separately along the baseboards, at least two inches apart, to that point where they will naturally separate going to their respective destinations. The ground clamp should then be put on a clean surface, making sure it is firmly tightened; it is good policy at this time to tell the customer to tighten this up again in about two weeks to take up the stretch in the metal. The ground wire should be put through the clip, and the end should be skinned for a length sufficient to wind around a few times. A loop of about three inches should be left at this point so the Service Man can disconnect it easily if necessary. This advice also applies to the inside connection of the lead-in strip.

Now for the antenna; if located in a large city, on top of an apartment building, it is advisable to put this up as high as is practical and about 100 feet long if possible. I have found that the man-made static level is reduced by a long antenna in most cases. This seems hard to believe, but I am writing from practical experience. Of course, if the set is located near a powerful broadcast station, the antenna will have to be shorter.

The lead-in wire should then be stripped for about three inches, and twisted a number of times about the antenna wire. As no connector for this purpose is sent with an antenna kit, twisting the wire is the best procedure I can suggest; it should

(Continued on page 369)

FACTS

Open every day including Sunday and Holidays.

We charge one dollar for a service inspection call.

Service man is on the job within an hour after call is received.

Two complete shifts of men working from 8 A. M. till 12 midnight.

25 service men equipped with meters to study your individual troubles.

All service men equipped with autos.

We convert A. C. sets to D. C. and visa versa, also change battery sets to electric sets.

Automobile radio sets installed and serviced.

REAL RADIO SERVICE

main office
550 State Street, Brooklyn, N. Y.

CUMberland 6-4060
6-4059
6-4061

A few well-chosen paragraphs outline the complete service. Lettering is red on blue; card measures 4 x 6 1/4 in.

Does the shoemaker repair your watch?
Does the baker repair your clothes?
Does the fish man repair your roof?
Does the electrician repair your plumbing?

KRAZY?

WELL — then why do you call a Butcher to repair your Radio?

Every service man employed by REAL RADIO SERVICE is a qualified radio engineer, whose ability has been proven by many years experience.

All work done by REAL RADIO SERVICE is absolutely guaranteed.

REAL RADIO SERVICE

main office
550 State Street, Brooklyn, N. Y.

CUMberland 6-4060
6-4059
6-4061

A "catch" heading. This is the reverse side of the card illustrated at the left of this page.

KOLSTER — INTERNATIONAL MODELS K-60 AND K-62
SCREEN-GRID SUPERHETERODYNE CHASSES

With the circuit reproduced below, Kolster Radio, Inc., introduces one of its new radio receiver models.

The circuit incorporates band-selection, tone-control, electrolytic condensers in the filter circuit, type '24 screen-grid first- and second-detectors, a single-stage type '35 variable-mu I.F. amplifier operating at 175 kc., and a pentode-type power output tube.

Operating voltages are as follows: Filament potential, (see circuit). Plate current, V1, V3, 6 ma.; V2, 1. ma.; V4, 7 ma.; V5, 0.2-ma.; V6, 24 ma.; V7, 48 ma., per plate. Control-grid potential, V1, 0.25-volt; V2, 6.4 volts; V3, zero; V4, 3.5 volts; V5, 4.2 volts; V6, 2 volts. Plate voltage, V1, 230 volts; V2, V4, V6, 225 volts; V3, 85 volts; V5, 125 volts. Screen-grid potential, V1, V4, 80 volts; V2, 74 volts; V5, 22 volts; V6, 245 volts. Cathode potential, V1, 3 volts; V2, V5, 6 volts; V3, zero; V4, 4 volts. Many of these readings may be deceptive, due to the circuits having high resistance.

The resistor color-code is as follows (first is the body color; second, top; third, dot): 5,000 ohms, green-black-red; 10,000 ohms, brown-black-orange; 25,000 ohms, red-green-orange; 200 ohms, red-black-yellow; 100,000 ohms, brown-black-yellow; 0.25-meg., red-green-yellow; 1 meg., brown-black-green.

The fixed condensers may be identified by the following code: .0002-mf., gray; .00075-mf., yellow; .001-mf., orange; .0015-mf., blue; .003-mf., pink.

A special feature is the incorporation of a hum adjuster across the filament leads of the pentode. Note that heavy duty resistors are used; this type of unit serves to maintain voltages constant.

These models were tested on 115 volts. Should lower line voltages be encountered, it will be necessary to remove the chassis from the cabinet and unsolder the blue lead, which comes from the underside of the power transformer and is connected to one side of the line switch mounted on the rear of the volume control. In its place solder the green lead, taping the end of the blue lead just removed. A line

resistor will be required if the line potential exceeds the figure given above.

Located on the front of the gang condenser are three trimmer condensers in shunt to the signal-frequency-tuned circuits. The 600 kc. trimmer condenser for the oscillator will be found on the right-hand top of the chassis base, directly in front of the '80 socket.

Caution: Never turn on the set when the reproducer is disconnected.

Located on the front of the gang condenser are three trimmer condensers (TC-1, 2, 3) which are provided for aligning the R.F. circuits. The 600 kc. trimmer condenser (OC-1) for the oscillator will be found on the right hand top of the chassis base directly in front of the '80 socket and opposite the coil shield. Poor tone, lack of sensitivity and selectivity, or complete inoperation of the receiver may be caused by these condensers being out of adjustment.

Place the oscillator in operation at exactly 1400 kc. and couple it to the antenna. Connect the output device in accordance with the type used. Tune in the oscillator signal and adjust the coupling between the oscillator and the antenna lead of the set, or increase the volume control setting until a deflection is obtained in the output meter.

With an insulated screw driver adjust each of the trimmer condensers mounted on the gang condenser frame until a maximum deflection is obtained in the output meter. If the pointer goes off scale, reduce the coupling or the volume control.

Set the oscillator now at 600 kc. Tune in this signal with the receiver and adjust coupling or volume control for a deflection in the output meter. Now adjust the oscillator 600 kc. trimmer condenser (OC-1) until a maximum deflection is obtained. In making this adjustment it is advisable to rock the tuning condenser back and forth a few degrees each side of the normal position.

Change the setting of the oscillator back to 1400 kc. and readjust the three trimmer condensers.

If attention is given to the adjustments the R.F. and oscillator circuits will be properly aligned and satisfactory results should be obtained. If not, the next step is to adjust the I.F. circuits.

A single I.F. stage with two transformers is used in band-pass arrangement. Primaries and secondaries are tuned to 175 kc. To adjust, proceed as follows:

After putting the the oscillator into operation, and connecting the output device, remove the oscillator tube (the '27 adjacent to the '80), and make a good ground connection to the chassis.

Connect the oscillator to the control-grid cap of the first detector, a '24, and adjust the oscillator output or the receiver volume control until an output deflection is obtained.

Place the chassis on end and the adjusting screws for the I.F. transformer condensers (1C1, 1C2, 1C3, 1C4) will be found through holes in the underside of the base after the bottom shield has been removed.

Adjust the secondary and primary of the first and second I.F. transformers in the order just mentioned until a maximum deflection is obtained at the output meter. Make these adjustments the second time to insure proper aligning. It is now advisable to recheck the R.F. and oscillator condensers again.

The by-pass condensers may be tested by noting the leakage time; the electrolytic units, by noting the leakage current. This should not exceed 3 ma. per 8 mf., tested 4 mins. after charging with 400 volts D.C.

It is often desirable to operate one or several extra speakers at a distance from the radio receiver. If a dynamic speaker is used, it will be necessary to obtain a unit having its own output transformer and source of field supply. Connect the primaries of the two output transformers in series.

To use a magnetic unit, connect the two leads from the magnetic speaker in parallel with the primary of the receiver's output transformer. This connection can best be made by soldering the magnetic speaker leads to the red and black leads coming from the speaker plug.

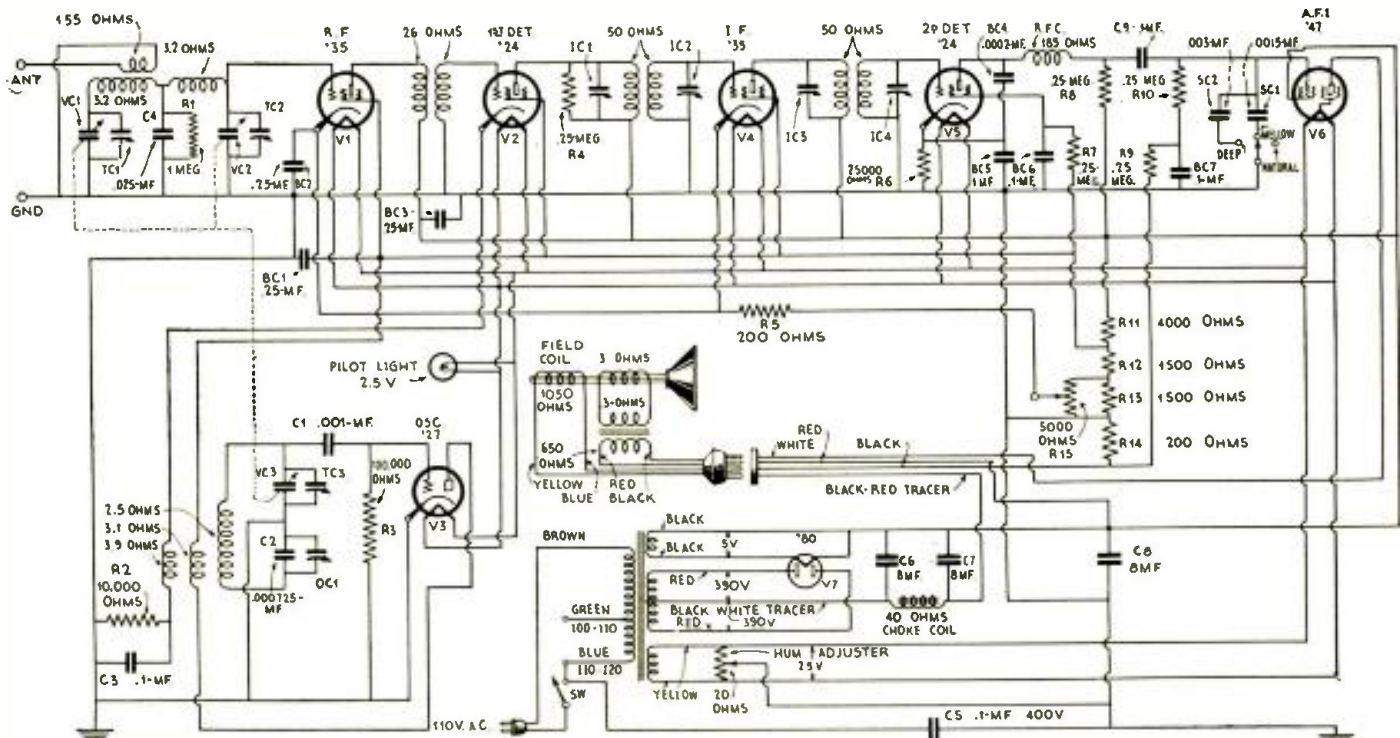

Schematic circuit of the new Kolster-International Models K-60 60-cycle, and K-62 25-cycle radio receivers. The antenna is inductively-coupled to a band-selector preceding a single-stage signal-frequency amplifier using a type '35 variable-mu tube. The tuning characteristic is flat-top. The set must not be turned on when the reproducer is not plugged into circuit. Power detectors are used.

U. S. RADIO AND TELEVISION MODELS 99 AND 99X

Pentode (5-tube) Superheterodyne Receivers

Perhaps the most simplified commercial superheterodyne receiver as yet developed is the No. 99 chassis, a circuit of which is shown below.

The design includes a combination oscillator and first-detector V1, using a type '24 screen-grid tube; an I.F. amplifier V2, using a type '35 variable-mu tube; a second-detector V3, using a type '24 screen-grid tube; a pentode power output tube V4; and the usual '80 rectifier V5. Note the absence of a separate oscillator tube. The intermediate frequency is 262 kc. A band-selector precedes the detector-oscillator.

A surge of energy fed into the secondary of the oscillator inductively causes this circuit to begin to oscillate at its resonant frequency, 262 kc. above the signal frequency. This oscillator frequency is fed back through the tap in the secondary coil into the grid circuit of the first-detector. There, the oscillating signal is amplified and fed inductively through the primary system in the plate circuit of the tube back into the secondary, thus sustaining the oscillations at the frequency to which the oscillator secondary circuit is tuned.

Operating voltages for this receiver are as follows: Filament potential, V1, V2, V3, V4, 2.25 volts; V5, 4.9 volts. Plate potential, V1, V2, 165 volts; V3, 128 volts; V4, 205 volts. Screen-grid potential, V1, V2, 65 volts; V3, 60 volts; V4, 225 volts. Plate current, V1, 1.3 ma.; V2, 6.4 ma.; V3, 0.22-ma.; V4, 29 ma.; V5, 27 ma. per plate. Control-grid potential, V1, 4.5 to 5.25 volts; V2, 2.5 volts; V3, 6.5 volts; V4, 16 volts. Screen-grid current, V1, 0.4-ma.; V2, 1.5 ma.; V3, 0.05-ma.; V4, 8 ma. Cathode potential, V1, 4.5 to 5.25 volts; V2, 2.5 volts; V3, 6.5 volts.

Connections to the power transformer assembly are given in the illustration of this portion of the receiver.

The bias voltage on the first-detector will vary, depending on the frequency to which the receiver is tuned. The voltage is the highest at the center of the dial and drops off at both ends. The reason for this change in bias voltage is due to the change in the oscillatory current with change of frequency setting.

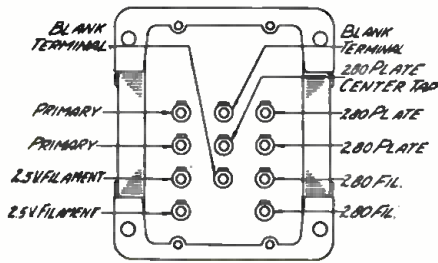

Power transformer terminal connections of the Model 99 Chassis.

All plate readings are measured with a 600,000 ohm meter. The second-detector screen-grid potential must also be read with a high-resistance meter owing to the resistance in this circuit. The pentode grid voltage cannot satisfactorily be read at the socket between the grid and filament owing to the high resistance in the grid circuit. This potential must be read across the 300-ohm section of the voltage divider resistor at which section the bias voltage for this tube is developed.

Should the circuit oscillate on being connected up, it may be due to type '35 or '24 tubes whose characteristics vary considerably from the standard. Also, check the ground connection; and note also the line potential.

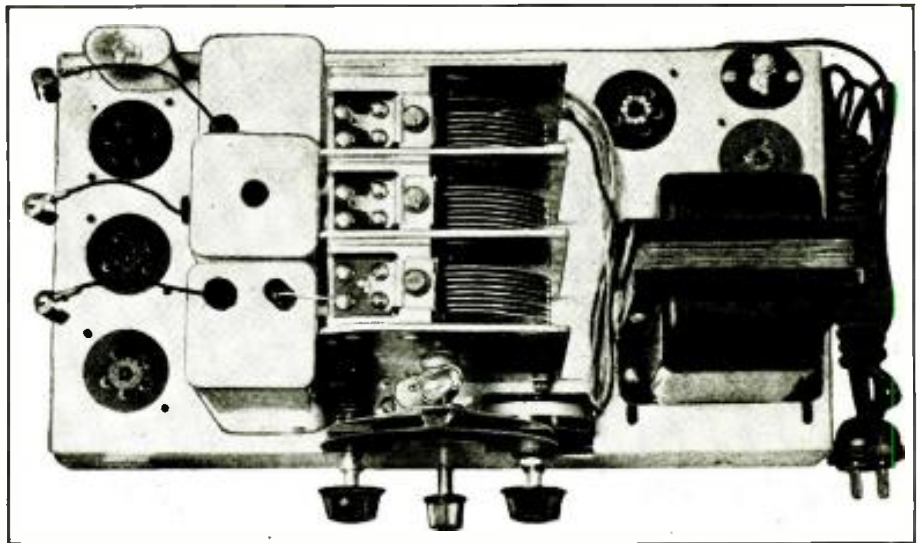

Parts arrangement on top of the Model 99 receiver chassis. To prevent circuit oscillation it is essential to keep all leads short and in correct location. For good operation, an important item is good tubes.

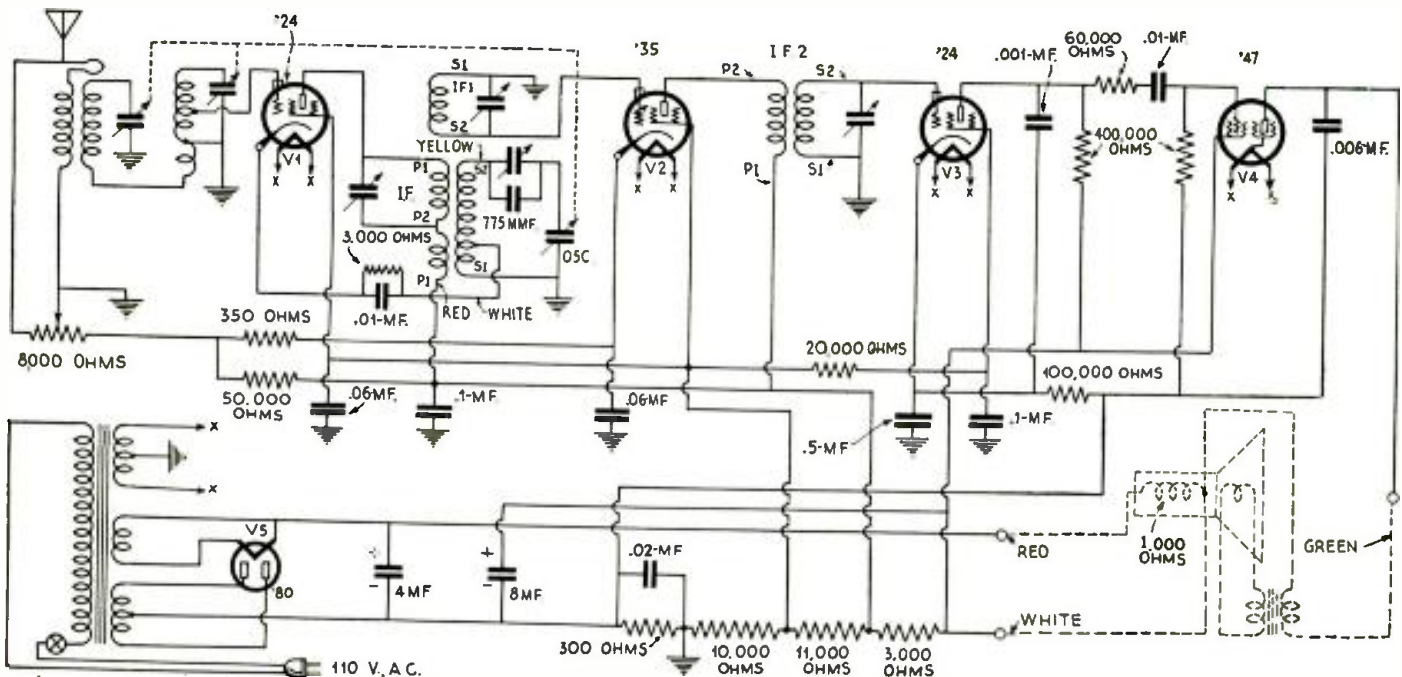

Schematic circuit of the Models 99 60-cycle, and 99X 25-cycle superheterodyne receivers. A band-selector precedes the first-detector-oscillator, 1'1. The signal frequency settings of the service oscillator must be accurately known, as the dial is calibrated to read directly in broadcast band frequencies.

Favorite Radio

The "pet" testing equipment of Service Men is described in detail by the Service Men themselves.

A ONE-METER SERVICE UNIT By Henry E. Sigle

ALTHOUGH any number of articles on resonance indicators have been published in various radio magazines, the writer has seen none that are as handy or that cover such a range of usefulness as the one to be described.

As seen from the diagram below, the unit is a combination resonance indicator and vacuum tube voltmeter. It may be used to measure receiver output, or to balance and neutralize R.F. stages. One meter is thus used for two purposes, which is an item of importance in the small shop.

The capacity C should be very small (about 100 mmf.) and should be so adjusted that as resonance is approached the pointer of the meter drops gradually and returns to normal just as gradually when the resonant point is passed. If in passing the resonant point, the pointer "breaks" and quickly rises to normal, it is an indication that C is too large.

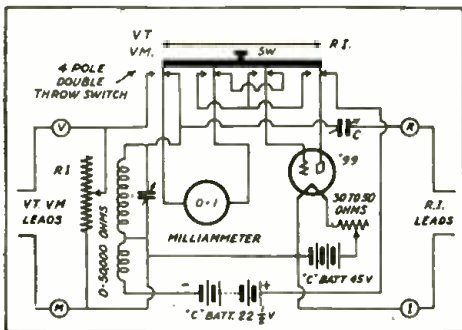

Diagram of the single unit tester. When the switch is thrown to the left, it is a vacuum tube voltmeter; when thrown to the right, it is an oscillator and resonance indicator.

The coil-condenser tuning arrangement may be any that covers the band required, and may be salvaged from an old set if so desired. It is advisable to use either a vernier condenser or a vernier dial. A larger tube V may be employed (thus allowing the use of a less sensitive meter, or even a cheap "B" battery voltmeter with its resistance removed). This, however, destroys the portability of the instrument through the use of heavier filament batteries.

With the switch SW thrown to the R.I. side, we are ready to align condensers.

For such sets as Crosleys that have the tuning condensers entirely enclosed, we use an old tube base with the lead from R soldered to the first grid prong for aligning the first two stages, the lead I being always grounded to the chassis of the receiver. The end of the condenser shaft on the stage to be aligned is slotted with a hacksaw to facilitate turning the condenser when the set screws are loosened. (All aligning should

be done with the small panel balancers at the neutral or center positions.) Each condenser should be set so that they are all resonant for the same position of the R.I. dial. For the detector stage it is necessary to attach R to the coil end of the grid condenser. All of the above applies to receivers that use the neutrodyne method of oscillation control.

For sets that use the grid resistor or "losser" method, such as the Atwater Kent, it is necessary to connect R to the coil end of the grid resistor, a battery clip being used for this purpose.

It is important to keep the relative position of the lead R constant with respect to the various parts of the receiver. To accomplish this, we use in our shop a rubber band attached to the ceiling in order to hold the lead up over the set, allowing it to drop straight down to the condenser under test.

With the switch on the V.T.V.M. side, the unit may be used to measure set output, to balance or neutralize receivers by the conventional methods, or for any of the number of things for which this device is suitable.

The entire arrangement, including batteries, is built in a box 12 x 4 x 6 ins.

AN INEXPENSIVE CAPACITY METER By E. M. Hanken

HOW often has the Service Man wished to know the capacity of a certain filter or by-pass condenser, but, like the most of us, found that the usual capacity measuring instruments were too expensive to own? Of course, the larger sizes can be measured approximately by the use of an A.C. ammeter, but this method will not measure the smaller condensers easily.

The writer has solved this problem by using the circuit shown in Fig. 1.

The parts needed are a 0-1 milliammeter, which is a very useful instrument that most Service Men have on hand, a Westinghouse dry disc rectifier (such as used on the old

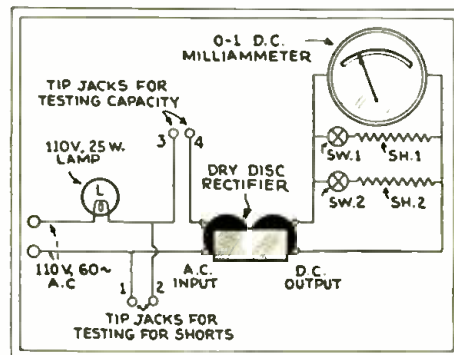

Fig. 1

Circuit connections of the capacity meter. A dry-disc rectifier in conjunction with a D.C. meter is used for measuring values between .005- and 10 mf.

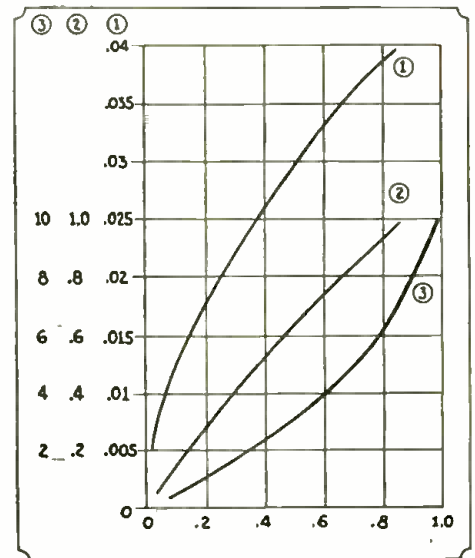

Fig. 2

The values of capacity are obtained directly from the curves above. The abscissas correspond to the meter readings, and the vertical lines to capacity. Curves 1, 2 and 3 correspond to the different values of shunts used.

Rectox trickle charger and on some dynamic speakers), a 25 watt, 110 volt lamp and socket, two toggle switches, four 'phone tip jacks, and a pair of cords.

The diagram is self-explanatory. The shunts are home made of 0.016-in. diameter nichrome wire. Shunt No. 1 is approximately 3 ins. long, and should be adjusted to read exactly 0.9-ma. with a good 1.0 mf. condenser in the circuit. Shunt No. 2 is 0.5-in. long, and should be adjusted to read 1.0 ma. with a 10 mf. condenser in the circuit. The terminals on these shunts should be clamped rather than soldered, because solder does not "take" well to nichrome wire.

These readings may show a slight variation with different rectifiers, but after a few checks on condensers of known capacity, the service man will be able to determine capacities at least within the accuracy with which the average commercial condensers are made.

For checking smaller capacities than about .005-mf., the writer would advise the bridge balance method, but the above scheme gets most of the troublesome ones.

By reference to the diagram, two sets of tip-jacks will be found. If a condenser is to be tested for a short, it is connected between terminals 1 and 2. If the condenser is shorted the lamp will light up, if not, the lamp will not light. On the other hand, when a condenser, known to be good, is to be measured, then it should be connected between terminals 3 and 4. The resulting meter reading should then be referred to the chart reproduced in Fig. 2.

Testing Equipment

ADAPTER FOR TESTING RECTIFIERS

By Alfred Pogany

IN altering a tester for sets and tubes, which I made some years ago for use with battery-operated receivers, I found the device described very handy and, as it is easy to duplicate, I think other Service Men will find it useful.

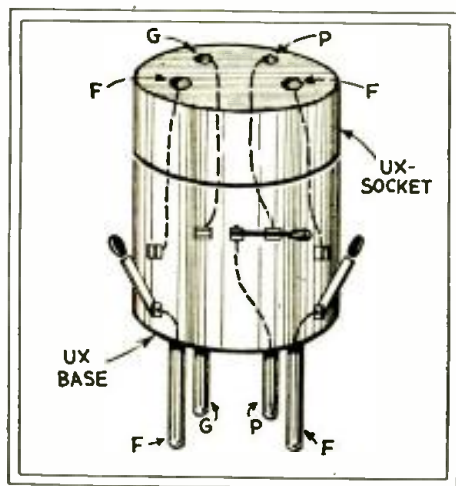

A sketch of the adapter used for testing "BH" rectifiers. The switches are for the purpose of conveniently changing the socket connections.

The ordinary tester has a milliammeter in series with the plate lead. To measure or test rectifier tubes of the filament type, it is necessary to swing the plate lead alternately to the "P" and "G" on the socket of the rectifier—that is, to one or the other plate.

In a gaseous ("BH") rectifier, the "plates" are connected to the filament prongs, and the test consists of disconnecting one anode and, after observing the meter reading on the other, rearranging the connections for the other reading.

This adapter is made of a UX tube base and a Pilot UX sub-base socket, two S.P. S.T. and one S.P.D.T. switches. Such switches can be bought for 10 cents; I had them, and to make the adapter as compact as possible, I removed the blades and points from their bases and used the shell of the UX base to mount them as shown. Since the rectifier plates carry fairly high voltages, to avoid a possible shock I removed the small fiber insulation from the switch blades and borrowed three celluloid tips (disguised as bakelite tips), from Friend Wife's umbrella while she was not looking. These I placed on the switch blades as new handles.

The entire arrangement is very compact and may easily be carried in any service kit. While the use of gaseous rectifiers is becoming less and less as time goes on, the Service Man can never tell when he is going to "strike" one in the field.

CALIBRATING VOLTMETERS

By A. R. Haidell

HIGH-RANGE D.C. voltmeters, suitable for testing power-supply units, are expensive. The Service Man usually has available, or can buy at small cost, a good low-range meter, for the reason that such are in more common use; his problem is to calibrate the voltmeter for high voltages with a reasonable degree of accuracy.

Perhaps the simplest method is to connect some high-resistance units in series and, with the aid of the low-range meter, measure the drop across a known fraction of the total resistance. Thus, for example, suppose that five small 110-volt, 10-watt lamps are connected in series across a D.C. supply of 500 volts (such as the supply to a transmitter) furnished by a rectifier, or a small generator. The voltage across each lamp can be measured; and the sum of these voltages will be the total available.

For this work a high degree of accuracy is usually not necessary. The voltages across the lamps, or resistors, are measured; the sum of the readings being the total voltage of the source. A resistor (in this case having approximately four times the resistance of the voltmeter itself) is then connected in series with the instrument; and the meter is connected directly across the high voltage. The scale is then marked with the measured value previously

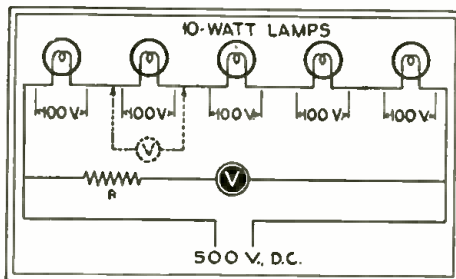

The voltage drop across each lamp should be 100 volts, if five 10-watt lamps are connected across a 500 volt source.

determined. If the D.C. voltage is variable, a low value should be used at first; and various readings can thus be obtained. A "B" unit which is known to be in good operating condition can be used for calibration purposes; but the load taken by small lamps will be too great. Resistors of suitable value should be used in this case.

AN IMPROVEMENT IN OHMMETERS

By C. Porter Ferrell

THE average Service Man is familiar with the need for an ohmmeter of some sort as the most convenient means of checking up on the various resistors with which the modern radio set and power-pack is blessed.

For general use these instruments seem to fall into three different classes; the continuity test type, Fig. 1, the slide-wire bridge type, Fig. 2, and the two meter

type, in which the unknown resistance R is determined by the application of Ohm's Law, $R=E/I$, Figs. 3 and 4.

The first is quite convenient as far as portability is concerned; it gives direct readings of resistance over its entire range, and

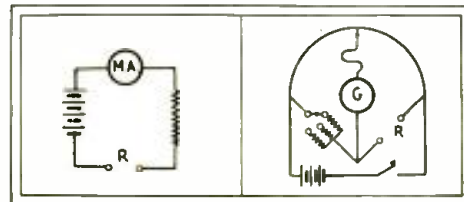

Figure 1. left. The usual circuit diagram of a continuity tester.

Figure 2. right. The slide wire bridge method of measuring resistance.

it is most useful as a continuity tester aside from its value as an ohmmeter. It falls down chiefly in that its useful range is quite limited, since the scale is crowded for the higher values of resistors.

The second type in which a rotary slide-wire, standard resistances, galvanometer, etc., provide a true bridge method of measuring resistors, is not so common, although at least one instrument maker has marketed such a device for radio service. Unless an expensive galvanometer is used, the sensitivity of the instrument is poor, and the accuracy suffers accordingly; and, as in all slide-wire bridges, the per cent error increases rapidly as the balance point moves from the center of the slide wire.

The third type using a continuously variable E.M.F., a voltmeter for reading E, and an ammeter (usually the 1.0 ma. range) for reading the current through R, is direct reading (if the current is made some decimal factor of unity, then the volts read on the voltmeter divided by the decimal multiple of unity gives the value of R in ohms), the scale being necessarily evenly divided, and, while the accuracy is better for some values than others, with good meters it is possible to obtain excellent results in a short time.

There have been various articles on the construction of ohmmeters; the first two types are not particularly easy to calibrate without the use of standard resistances, but the third requires no extra equipment aside from a voltmeter reading up to ten volts

(Continued on page 370)

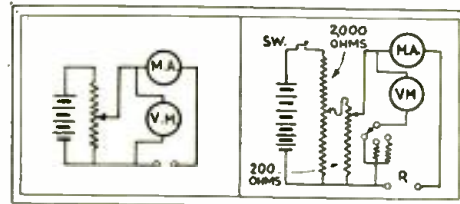

Figure 3. left. The voltmeter-ammeter method of measuring resistance.

Figure 4. right. The final circuit of the improved ohmmeter.

Operating Notes

The Analysis of Radio Receiver Symptoms

BY BERTRAM M. FREED

WHILE on the trail of the elusive hum some time ago, an effort was made to determine the cause and cure of this annoying condition, which is present in most of the Zenith "50" series receivers. Several sets were taken down for purposes of isolating or locating the fault of the complaint. The very first move was the substitution of power transformers with those of different manufacture, but this was of no help. Electrolytic condensers were changed and larger by-pass condensers were employed in the different circuits, all to no avail. Condensers were connected across the filter chokes in various tuned filter circuits. These changes in most cases reduced the hum a slight amount, but the result on the whole was not very satisfactory. However, one result was obtained, that of proving

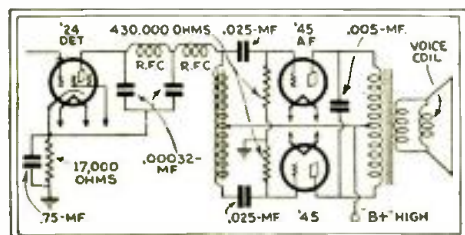

Fig. 2

Connections in R.C.A. capacitor and reactor packs.

definitely that the trouble did not lie in the filter circuit of the pack.

This receiver utilizes two stages of push-pull audio amplification, which is preceded by a single '27 audio stage. The second stage uses '27 type tubes in push-pull. When the '24 detector was removed, the hum still remained, pointing to the audio stages as the only possible source of the complaint.

Different sized carbon resistors were connected or shunted across the grids of the second stage '27 tubes. Finally a 250,000 ohm resistor turned the trick. The hum was almost entirely "killed" with very little decrease in volume. In some sets it was necessary to employ a 100,000 ohm resistor to obtain the same results. All steps taken in the elimination have purposely been set down so that hum in other receivers can be located in like manner.

Perhaps many Service Men have been confronted with a Majestic model "132" receiver that operated intermittently with some noise and fading. Especially when pressure was applied to the tuning knob did this complaint make itself known. The trouble was finally located in the rotor contact of the tuning condenser gang. The rotor of the gang is not electrically connected to the chassis but only relies upon a mechanical friction contact for its con-

nection. To get at the trouble, the shield must be removed from the tuning gang. At the front end of the shaft, in back of the dial and directly outside the bath-tub will be seen the friction collar upon which the copper contact rides. The contact will be found to be corroded and most of its tension gone. This contact should be removed by loosening and taking out the two screws that hold it. Polish it with steel wool and clean well. The friction collar should then be taken off by loosening the set screw, and the side which the contact arm rides on should be thoroughly cleaned of all oil and polished with sandpaper or steel wool. Before the shield is replaced, use a pipe cleaner on all the plates of the variable condensers and make certain that the plates are not in too close proximity to each other, as they may short, a more than infrequent complaint with these sets.

Perhaps the most common trouble found in Majestic sets since the Model "90" series receivers were turned out, is in shorted transformer units. Several months ago, mention was made of a shorted phono-pickup input transformer. The short turned out to be nothing more than the connecting lug biting into the core of the transformer—beneath the cardboard terminal strip. Since that time many primaries of push-pull input transformers have been found shorted in the same manner.

It is not necessary to discard the supposedly "shorted" unit, but only to disregard the lug terminal. Unsolder the transformer lead that connects to the lug and connect it directly to the proper circuit lead. This can be done conveniently, as the transformer lead is not soldered to the underside of the lug but emerges a short distance from it, the lug being used only as a means for coupling the two leads. This explanation will be more clearly understood by reference to Fig. 3.

Great care should be exercised in the handling of the new Zenette superheterodyne receiver, Fig. 1. This set uses a pair of 6 mf. electrolytic condensers in such manner that a high voltage exists between the cans of the condensers. The field of the dynamic speaker is used as a choke in the negative return of the filter system and is also utilized to obtain grid bias for the pentode power tube. Consequently, the cans of the electrolytics are above ground potential and carry sufficient "wallop" to cause physical injury. Incidentally, several cases of fading have been reported on this set and where it has not been caused by a defective screen-grid tube or poor soldered connections, it has been traced to either or both of the 0.1-mf. small tubular by-pass condensers in the first-detector and intermediate frequency grid returns. The remedy is obvious.

Where these receivers are found to be insensitive on the high frequency end of the scale, it is necessary to rebalance the condenser gang, which contains two compensators. These should be aligned at 1500 and 600 kilocycles respectively. In conjunction with these adjustments, the oscillator trimmer may also be adjusted with good results. This condenser adjustment is located on the side of the chassis below the R.F. coil and oscillator tube. The adjustment should be made at the low end of the scale. If the volume control shaft should become grounded to the chassis, then no control will be obtained. Loosening the mounting nut and resetting the insulating fiber washer will correct this condition.

A great deal of the fading experienced with most electric receivers is due to faulty tubes, generally of the screen-grid heater type. With the use of the ordinary plug-in set analyzer, it is very difficult to detect a fading tube unless much time is spent. Only in rare cases, will the Service Man have the fortune of locating the offending tube while on the job only a few minutes. However, the possession of an A.C. tube tester will prove of invaluable assistance in determining the tube at fault in only a few moments. Of course, every man has his own methods and ideas upon the subject of testing tubes, but the following material has been subjected to innumerable tests.

The tube tester is plugged into the alternating current supply and placed in close proximity to the set, which has been

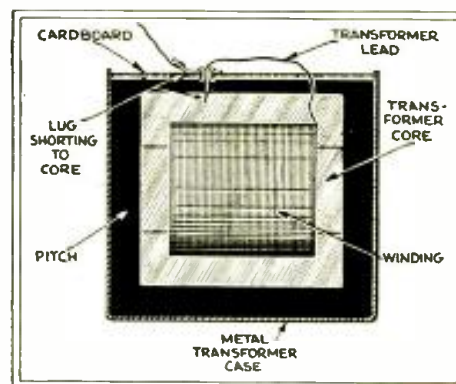

Fig. 3

Majestic "90" power transformer occasionally ground as shown.

turned or switched "on." The heated tube is placed into the tester and the control grid cap clipped into place. At once, the tube should be tested by pressing the proper buttons. If the tube is good it will pass the required milliamper reading and continue to hold that reading as the buttons are kept down. A bad tube will soon cause the meter needle to fall back, sometimes slowly and gradually and at other times in jumps of several milliamperes. After

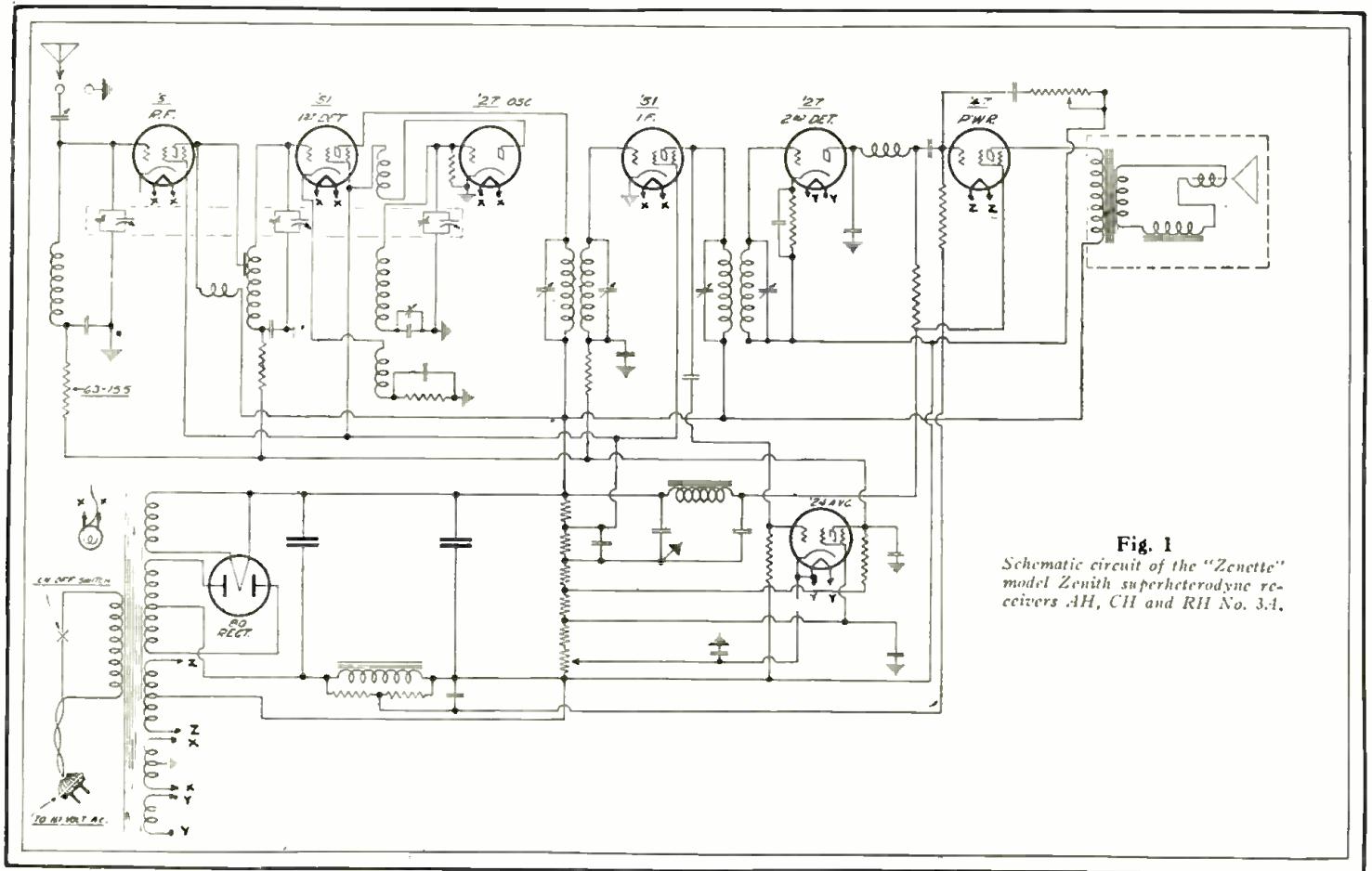

Fig. 1
Schematic circuit of the "Zenette" model Zenith superheterodyne receivers AH, CH and RH No. 3A.

testing the tube, and the meter does not fall more than one milliamper in the 90 second test, it is almost a certainty that the tube under test is good.

However, the test is not yet completed. After all tubes have been tested and good ones replaced in the receiver which is put in operating condition, each tube should be given several successive sharp taps in order to determine the possible existence of loose elements. Many of these "loose element" tubes have been found which check perfectly on a tube checker or analyzer, yet cause the set to fade and sometimes become inoperative upon vibration. The addition of one of these compact A.C. tube checkers is highly recommended as a valuable adjunct to any service kit.

On Radiola "48" and Victor "14" receivers, the conditions may be met where one of the '45 amplifiers is ineffective, or where the removal of one '45 tube will clear up an otherwise muffled and distorted reproduction. These sets employ a modified audio design, different than those usually met in standard commercial receivers. A tapped high impedance audio choke acting as an auto transformer, and coupling condensers are utilized to more effectively couple the '21 detector to the '45 tubes in push-pull. In addition, two leaks, each 430,000 ohms, secure the necessary grid bias for proper operation of the '45 power amplifiers. Should one of the .025-mf. coupling condensers short, a very high plate current reading will be obtained on the '45 tube, with consequent distortion and poor quality. Likewise, if one of the 430,000 ohm leaks should open, the same effect will ensue. Most often, however, these coupling

(Continued on page 371)

Servicing Majestics

By Jas. P. Smith

WHEN new tubes are placed in the Majestic "70" series they may cause the set to oscillate on the high frequencies; this is natural, as the new Majestic tubes have a slightly lower grid-plate capacity than the set was originally balanced for. If a balancing wrench is handy this can be quickly remedied by backing up about an eighth of a turn on the three balancing condensers located between the R.F. and detector tubes. Even though this usually clears up the trouble it is best to use the regular balancing procedure.

When it is desired to have proof that a set is properly balanced, a simple system as outlined here is recommended. A roll of transparent gummed paper tape can be purchased at a music or stationery store, and can be used to make a dummy from a good tube by tearing off a short piece of tape and sticking it around one of the

filament prongs of each of the R.F. tubes as it is being balanced out. This insures that the internal capacity of each tube has been balanced out and removes the hazard of the dummy tube having a different capacity from that of the tube to be used in the set.

In the Majestic "90" series it has been found that an aerial that is excessively long will cause oscillation, and sometimes a set that will not whistle without an aerial will do so with one. The remedy is to shorten the aerial.

The Majestic "52" series came out before the advent of the multi-mu tubes but circuit constants are such that the G-24 tubes can be replaced with the multi-mu G-51's and will show a vast improvement as to noise level and cross-talk. This change improves the set so that it compares favorably with the new model "21" series.

Numbers of Majestic superheterodynes have given trouble because the beat frequency oscillator would either work intermittently or refuse to work at all. It seems that the 150,000 ohm resistor from grid to ground is very important, and that the ones used for quite a while are subject to defects. To determine if the oscillator is working, remove the tube from that socket and note the difference in reception.

The tone of the superheterodyne will be distorted if the antenna coupling condenser is not adjusted correctly. On the "60" series this should be done with the aid of the meter on the front as the ear is ineffective against the automatic volume control. A "60" series volume control will have no effect if the A.V.C. tube will not pass current.

(Continued on page 371)

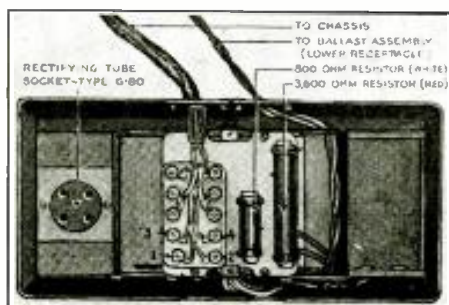

Fig. A

Power distribution plate in Majestic radio sets. Note the off-set position of terminal No. 1.

RECORDING STUDIO DESIGN

By GEORGE J. SALIBA, S.B.

INSTANTANEOUS recording, while originally intended for use in the home, lends itself very nicely to commercial applications. In the first article of this series on recording (see the June 1931 issue of RADIO-CRAFT), these applications and the different uses to which instantaneous recording could be lucratively put were pointed out, and now it is the purpose of this article to give a more technical description of the apparatus and how it should be used.

Commercial studios for instantaneous recording can be divided into two separate types—first, studios devoted exclusively to voice recordings and individual instrument playing and, second, studios that have facilities for recording complete orchestras and bands.

In the first type of studio only one microphone is used and the recording machine, amplifier, etc., are all located in the same room with the microphone. This room usually contains about 12 sq. ft. of floor space, and the over-all frequency characteristic is not made very flat since it is rarely necessary to record any frequency above 4,000 cycles. A moderately priced two-button carbon microphone is used in conjunction with a suitable amplifier whose gain is about 75 DB, and a made-over pick-up is all that is necessary as equipment. For the recording machine an ordinary phonograph turntable is all that is necessary if pre-grooved records are to be used, but if blank uncut records are desired for recording, then it is absolutely essential that an excellent feed-screw device be used in order to insure a good even groove. As has been pointed out in previous articles, if the recording machine makes a periodic groove—that is, the lines

are unevenly spaced, when the record is played back the results will be poor and if steps are not taken to prevent this, the finished product will only serve to cast reflection on the studio with a consequent loss of business.

A piano should be provided for accompaniment and it is usually a good policy to have a person who is a pianist run the studio. This will cut down labor costs and at the same time attract the singers who usually are very reticent about singing if accompaniment is not easily provided. For playback, the acoustic phonograph is best. The reason why this type of machine is recommended is that if the finished record

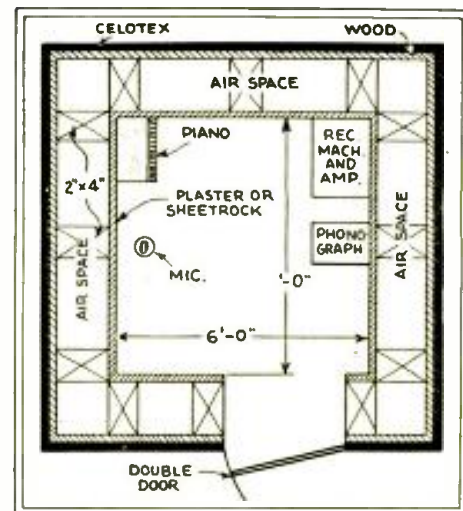

Fig. 1

Interior layout of a sound recording studio. Dimensions are given.

plays back satisfactorily on it, the customer is assured of success in his own home. Too many of these small studios that are rapidly springing up all over the country use inefficient apparatus and naturally their results are poor. To compensate for these poor results on playback, electrical reproduction is used and the record then sounds quite satisfactory in the studio, but when it is reproduced in the home on the old style phonograph (of which there are still many in existence) the results are very poor. The reproducer may be too heavy or the groove may not be deep enough with the result that there is double tracking. The customer is dissatisfied, and therefore any future business from him is lost. Instead of becoming a supporter, he turns "knocker." In the writer's opinion, the acid test for any instantaneous record is the acoustic phonograph. If the record sounds well on this, then it will sound much better on any other type of machine.

Acoustical Treatment of Studios

In most of the studios that the writer has had occasion to come in contact with, the acoustic treatment of the studio has been simply to cover the walls and ceiling with heavy drapes and the floor with a heavy carpet. A studio that is so treated will prove unsatisfactory for recording from the standpoint of fidelity. The record will sound "tubby" and very unnatural. This is due to the absorption of all the high frequencies by the heavy drapes. For proper acoustics the studio should be so constructed that there is a certain amount of resonance present so that the high frequencies may be properly recorded. In the proper treatment of recording rooms two objects must be kept in view; first, the exclusion of all unwanted external noises, and second, the production of the right acoustic conditions for good recording.

The excluding of extraneous noises is accomplished by building the room of double walls (see Fig. 1) with a dead air space between them. The dead air space is an excellent insulating medium against sound and is very effective in keeping out external noises. Great care must be taken to see that the walls and ceiling are all absolutely air tight. If this construction is carefully followed (Continued on page 373)

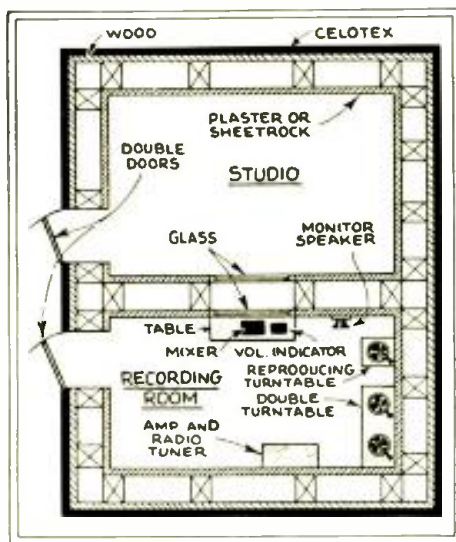

Fig. 2

A sound recording studio and control-room design. Double walls furnish adequate sound insulation.

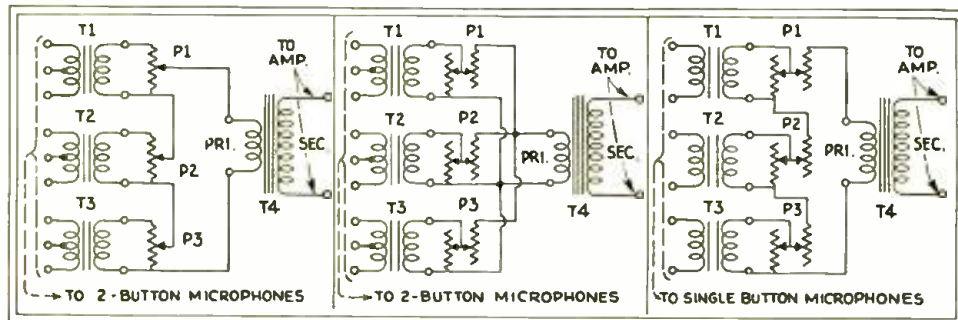

Fig. 4

The series potential divider type of microphone mixer.

Fig. 5

The parallel constant output impedance type of mixer.

Fig. 6

Series-type constant output impedance mixer.

The A.C. D.C. Portable-4

By H. G. CISIN, M.E.



Fig. A

Appearance of the A.C.-D.C. Portable-4 radio receiver, which has the advantage of versatility in its power requirements.

THE A.C.-D.C. Portable-Four receiver (illustrated in Fig. A), powered from any convenient 110-volt light socket, possesses many interesting and useful applications. For the traveling man, such a receiver is a splendid "companion," as he can use it practically any place he happens to stop. The Service Man can utilize this portable as an important aid in test work in the field, or to replace a larger set while the latter is undergoing repair at the shop. For emergency use, for camps, bungalows, or as an extra set in the home, it is ideal.

This receiver employs a simple but effective circuit, Fig. 1. There are two stages of tuned radio frequency, a tuned detector and a single resistance-coupled audio stage. The three tuned stages are "ganged" together, using a 3-gang shielded tuning condenser. Screen-grid tubes are used in the R.F. stages and detector, while the highly efficient pentode is used as the output power-tube. For A.C. work a type '80 rectifier is employed. This is not used when the set is connected to a direct current source, but it is left in the socket at all times.

Effective volume control is attained by means of a cathode series resistor of the

potentiometer type 12, designed especially for such use. An examination of the schematic diagram reveals a number of interesting features. The filaments of all four tubes are in series at all times, instead of being in parallel, as in the ordinary A.C. sets.

The line voltage is reduced to correct filament voltage by means of a 300-ohm resistor 33. This arrangement works equally well on A.C. or D.C., since the voltage drop through the resistor and filaments is the same in either case. Since all the tubes are of the heater type, wherein the filament serves merely as the heating element and is separate from the tube circuit proper, this series arrangement of the filaments does not affect the amplifying properties of the circuit in the least. Grid bias on each tube is obtained by the drop across a resistor, of correct value, between the cathode and the metal chassis.

The novel universal A.C.-D.C. feature of this circuit is the invention of Arthur C. Ansley, a New York radio engineer. Through the use of an ingenious switching arrangement, it is unnecessary to change the tubes or the wiring, when changing from an alternating to a direct current source, or vice versa. All necessary changes in the circuit are made, merely by slipping off a plug or cap at the rear of the receiver and replacing it with a second cap, marked for the kind of current to be employed. The caps have different connections, thus changing all the circuits which need to be changed. For example, by changing caps, the primary of the power transformer is connected to the line on A.C. and left open on D.C. This also takes care of the rectifier tube, since it is lighted from a winding on the power transformer. The D.C. line is connected to the input of the filter, with due regard to the polarity, so that the choke 39 and the electrolytic three-section condenser 36, 37, 38 remove the ripple from the plate voltage. The speaker field, which serves as the second choke on A.C., is connected directly across the line on D.C.

(Continued on page 375)

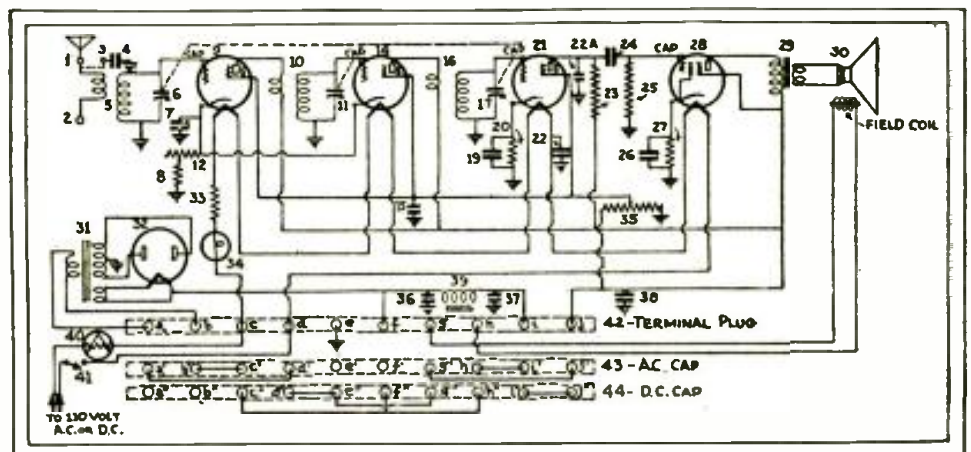

Fig. 1

Schematic circuit of the "Portable-4." Connecting terminal strip 43 or 44 to terminal plug 42 changes the wiring for A.C. or D.C. operation, respectively.

SERVICE-SELLING All-Wave SUPERS

(PART I)

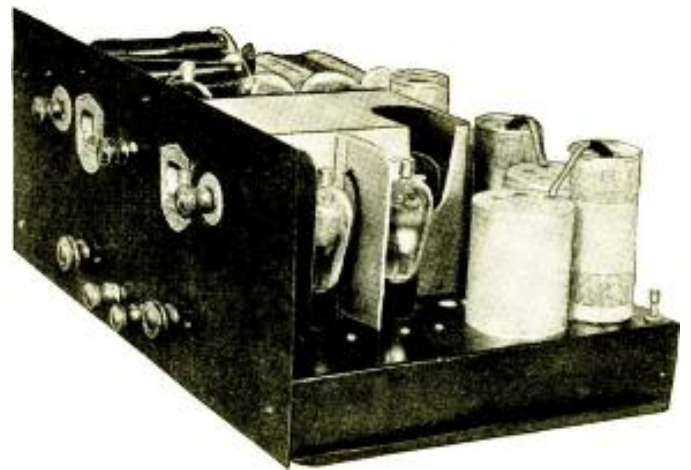

Fig. A

Contrary to general opinion, the problem of keeping a short-wave receiver sold is up to the Service Man who installs the set rather than to the floor salesman.

By McMURDO SILVER*

ARTICLES on short-wave design, construction, and operation have appeared in numerous past issues of RADIO-CRAFT (and the contemporary publication, SHORT-WAVE CRAFT), yet perhaps the most important point of all has not been clearly stated and discussed.

This is the fact that the selling of the short-wave and broadcast band receiver is, in the final analysis, the job of the Service Man. The dealer's salesman on the floor may get the customer to sign on the dotted line, but if the sale is to "stick," it is up to the Service Man who installs the set to properly instruct the customer. The Service Man must be thoroughly informed not only on general radio service, but also on the fundamental factors involved in satisfactory short-wave receiver operation.

Reception below 200 meters has not been particularly popular—if it may be said to have been at all popular—with broadcast listeners to programs of purely entertainment variety who now represent the bulk of the market. Buying a short-wave radio set and immediately expecting to be able to turn its knobs and, with

no understanding of what they are doing, get thoroughly enjoyable entertainment from it, is expecting the impossible; and if the receiver is sold by the average store salesman, any attempt he may make to show the customer how to operate the set (and in most cases he will make no attempt, for he does not know himself) will be carefully forgotten by the customer by the time the set arrives at his home.

Since the result will be no short-wave reception at all, and a prompt complaint will be lodged at the store, the writer feels that the most important aspect of short-wave receiver servicing today is the proper instruction of the store Service Man so that when he makes the initial installation of the receiver, he may intelligently show the customer what to do to get good results. The servicing of defective short-wave receivers is, in comparison to this problem, of decidedly secondary importance.

As practically all broadcast receivers today are superheterodynes, and as practically all of the "all-wave" receivers now available to the public employ the superheterodyne principle at least for the short-wave bands, consideration will be given here to the superheterodyne type of receiver only; and since its operation is con-

* President, Silver-Marshall, Inc.

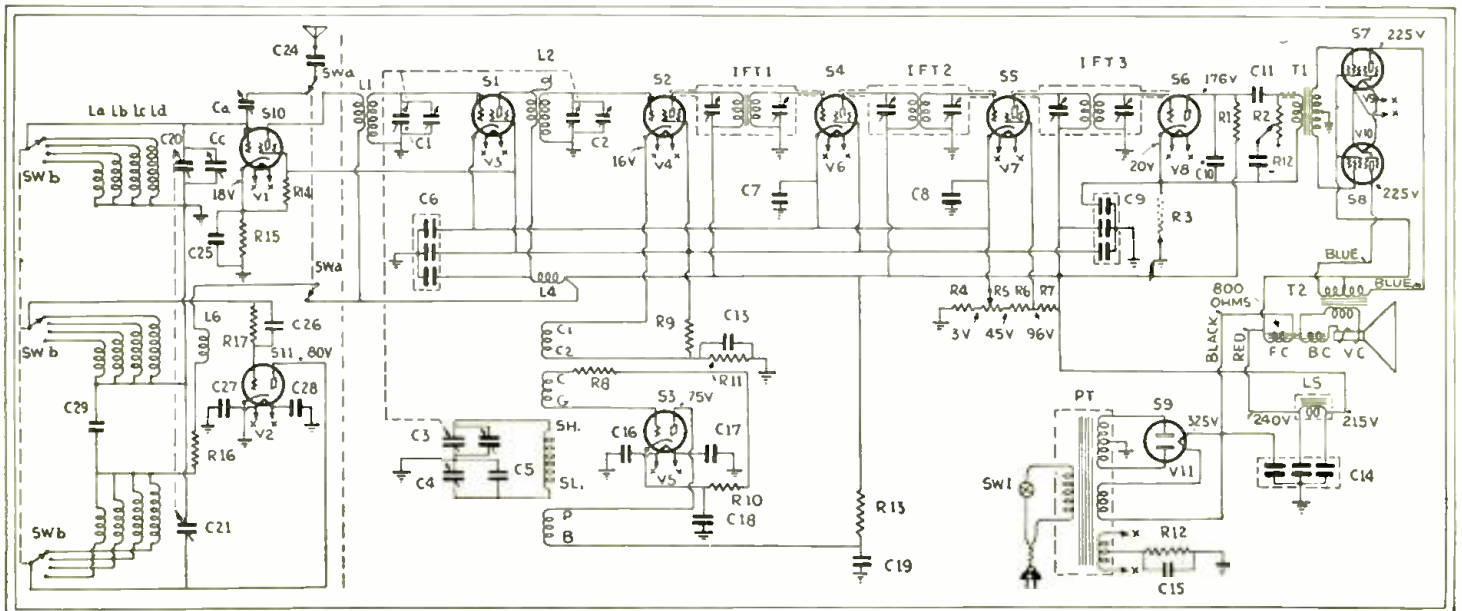

Fig. 1

The circuit diagram of the Silver-Marshall 726-SH short-wave receiver. The short-wave converter is shown to the left of the dotted line and the broadcast receiver, which is also used as the I.F. amplifier, is shown to the right.

SM AROUND the WORLD with the All-Wave SILVER-MARSHALL 726SW

In the 726SW there is available a combination of the very latest and most modern super-heterodyne broadcast and short-wave designs on one chassis.

In the 200 to 550 meter band, the 726SW is a nine-tube vario-mu pentode superhet employing nine tuned circuits. One precedes the '51 r.f. stage, a second is before the '24 first detector, and another with the '27 oscillator. The two tuned circuits ahead of the first detector, coupled with the '51 vario-mu tube, absolutely eliminate all cross-talk or image frequency interference. The two-stage i.f. amplifier, using '51 tubes, has a total of six tuned circuits (three dual tuned transformers) which definitely assures uniform and absolute 10 kc. selectivity at short or long waves.

A '27 second linear power detector feeds a compensated push-pull '47 pentode audio stage delivering from 5 to 7 watts undistorted power output, and in turn feeds a specially compensated electro-dynamic speaker unit.

The broadcast sensitivity ranges from less than one-half to seven-tenths of one microvolt per meter—so great that every station above the noise level can be tuned in easily. The selectivity is absolute 10 kc., and in any large city distant stations on channels adjacent to locals can be readily tuned in. From 60 to 100 different stations can be logged almost any night in any fair location.

The short-wave end of the 726SW is the dream of old—a true eleven-tube superhet using "double-suping" on not one, but two, intermediate frequencies. Yet it has but one dial—plus a non-critical trimmer! For short-waves, a '24 first detector and '27 oscillator ganged together are added by a turn of a switch, which selects between short-wave and broadcast band reception. A second selector switch chooses between four ranges (from 10 to 200 meters) at will—and all without a single plug-in coil.

The sensitivity, selectivity on short-waves are exactly equal to the broadcast band—giving thousands of miles of range.

Tubes required: 2—'24's, 3—'27's, 3—'51's, 2—'47's, 1—'80.

726SW All-Wave Superheterodyne, complete as described above, wired, tested, licensed, including S-M 855 electro-dynamic speaker unit. Size 20½" long, 12" deep, 8½" high. To be used on 110-120 volt, 50-60 cycle AC power. Price \$139.50 LIST.

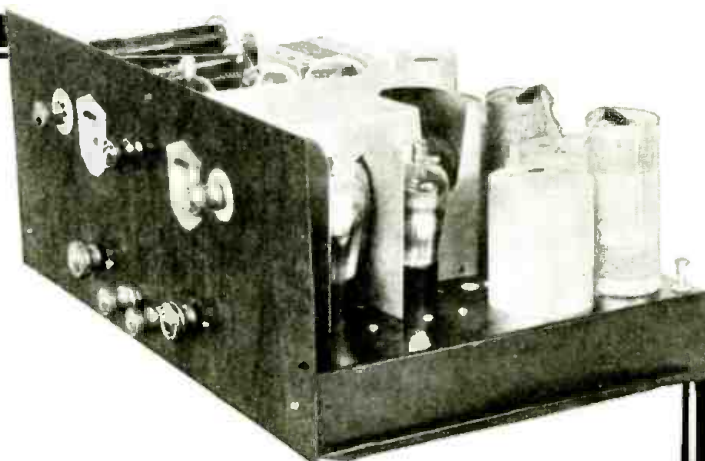

All in the 726SW

- Nine-Tube Broadcast Super
- Eleven-Tube Short-Wave Super
- No Plug-in Coil
- Pentodes in Push-Pull
- Three Vario-Mu Tubes
- Sensitivity Between .45 and .7
- Selectivity Absolute 10 kc.
- 10½" Electro-Dynamic Speaker

SILVER-MARSHALL, Inc.

6419 West 65th Street • Chicago, U. S. A.

Canadian Division: SILVER-MARSHALL of CANADA, Ltd.

75 Sherbourne Street, Toronto

Export Office: 41 Water Street

New York City, U. S. A.

SILVER-MARSHALL, Inc.
6419 W. 65th Street, Chicago, U. S. A.

Please send me full details on the S-M 726SW (enclosed you will find 2c).

Please send me FREE your new General Parts Catalog.

Name

Address

siderably more critical on short waves than is that of a T.R.F. receiver with a short-wave superheterodyne "converter" ahead of it, the Service Man mastering the operating technique of a thoroughly good short-wave superheterodyne will be more than competent to handle the few rare cases where he is called upon to install or service a T.R.F. receiver with a short-wave superheterodyne converter.

Example of Receiver

As an example, the Silver-Marshall 726-SW short-wave and broadcast band superheterodyne has been selected, for it represents one of the sharpest of broadcast band superheterodynes now upon the market. This instrument is illustrated in Figs. A and B; the schematic circuit is shown in Fig. 1.

As shown in Fig. A, there are seven controls on the front panel—three knobs at the top, and four at the bottom. The upper left-hand knob is the short-wave band selector switch SWb, having four positions which select the 10-20, 20-40, 40-80, and 80-200 meter

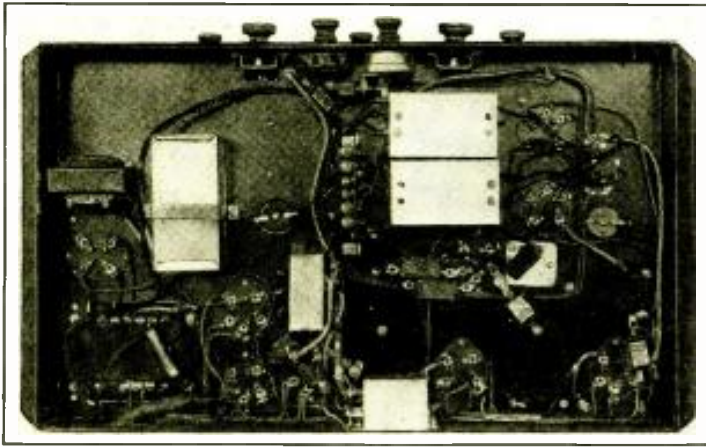

Fig. B

A photograph of the under-side of the Silver-Marshall Model 726-SW all-wave receiver.

bands. Directly to its right is the short-wave tuning dial, and directly below this, the short-wave tuning knob.

At the upper-center of the panel is the short-wave trimmer, Cc in Fig. 1, connected in shunt to the short-wave detector V1 grid-circuit tuning condenser C20, to permit accurate alignment between the short-wave oscillator and detector circuits, it being impracticable to gang these with the same accuracy as on the broadcast band where no manually operated trimmer adjustments are necessary.

To the right of this trimmer knob is the broadcast band tuning dial, and directly below it, the broadcast band tuning knob. At the extreme upper right is the range selector switch (SWa in Fig. 1) which permits the choice of either the short-wave (10 to 200 meters) or broadcast (200 to 545 meters) range. The two lower-center knobs are: left, the tone control, equally effective on short-wave or broadcast bands; and right, the combined volume control and on-off switch, likewise effective on both bands.

Examining the circuit diagram of Fig. 1, the portion to the right of the vertical dotted line is essentially a broadcast band superheterodyne, consisting of a tuned R.F. stage V3, a first-detector V4, an oscillator V5, two 175-ke. I.F. stages V6-V7, a second-detector V8, a push-pull pentode output stage V9-V10, and the usual rectifier, V11. To the left of the dotted line is the built-in short-wave converter, consisting of a first detector V1, and oscillator V2.

When the receiver is to be operated on the broadcast band, the switch SWa is thrown to the right. In this position, one set of contacts connects the antenna directly to the primary of the broadcast band R.F. transformer I.1 and to the plate of the short-wave first detector, although this is of no importance. A second set opens the plate circuit to the short-wave oscillator and the screen circuit of the short-wave first-detector rendering these circuits inoperative. The receiver is then tuned by the right hand dial, the volume and tone being controlled by the two lower-center knobs.

When the set is to be operated in the short-wave band, the switch SWa is thrown to the left, which connects the antenna to

the grid circuit of the short-wave first-detector through the compensating condenser Ca and closes the plate circuit to the short-wave oscillator and the screen circuit of the short-wave first-detector. Selection of the proper short-wave range is then made by the SWb, at the upper left of the panel, which selects the proper first-detector grid coil and the proper oscillator plate and grid coils for the particular band desired. When the switches are in this position, the receiver is essentially the dream of old—a "double super"—in that two I.F. frequencies, rather than one, are employed.

When the broadcast band dial is set to some clear channel near 650 kc. (necessarily only between 600 and 700 kc.) the short-wave oscillator serves to heterodyne the received signal to this frequency (which is the first I.F. frequency) where it is amplified by what would be the R.F. stage and first-detector on the broadcast band, but in this case is actually the first level of I.F. amplification and second detector. By means of the second oscillator of the receiver, this 650 kc. I.F. signal is re-heterodyned to the second intermediate frequency, or 175 kc., where it passes through the main, or second I.F. amplifier of the receiver to the third, or power detector, and thence into the push-pull pentode output stage.

All of this may sound extremely complicated, but actually it is very simple, and the only problems encountered are due entirely to the extreme selectivity of the receiver—its selectivity is many, many times superior to that of the best short-wave receivers heretofore available, while its selectivity on the broadcast band is superior to that of any competitive superheterodyne the writer has yet had the opportunity to examine.

Let us suppose a customer has received such a set, that it has been installed in his home without any instruction as to its operation, and that he happily tries to tune in signals on his new possession. He will, first, probably try the broadcast band, if he has taken sufficient trouble to examine the control legend on the receiver panel to see what he is doing. He will have no particular difficulty in tuning in broadcast stations, although he may have some difficulty in getting satisfactory tone quality, for his first step will be, unquestionably, to turn the volume of the control well up before tuning the signal in, then reduce the volume, with very excellent chances of not having the signal properly tuned in, and by virtue of the extreme selectivity of the receiver, cutting out some of the necessary side-bands.

The thing for him to learn is that in tuning a superheterodyne, he must tune in his signal at any volume level he wishes, then reduce it by means of the volume control (and *not* under any circumstance by detuning) until the signal is just audible, after which he must re-tune the signal and adjust his volume to the level he desires. After he knows this (and it is doubtful if he does at first, unless the store salesman has driven it very firmly into his head—which is likewise improbable) he will, after tiring of the broadcast band programs, attempt to tune in some short-wave signals and this is where his fun will begin.

Tuning an SW Receiver

Having tuned in a number of broadcast stations without any difficulty, he will expect the same thing to happen on the short-wave end of the set, and after putting it into operation by throwing the necessary switches, he will gaily turn the short-wave tuning dial, only to hear nothing at all except a good background noise. After doing this several times over a period of a few hours, he will be thoroughly disgusted, will call up the store and tell them to send out a Service Man in a hurry, for the set won't work—or else he will tell the store to pick up the set—that he doesn't want such a "—— piece of junk." Whereupon the Service Man will probably be sent out to show him that the set really is not so bad after all and that all he needs to do is learn how to operate it. Needless to say, it is vitally essential that the Service Man know how to operate the set himself.

The writer can not impress too strongly upon the Service Man reading the foregoing paragraphs, the absolute necessity of implanting firmly in his mind the ideas they contain, for upon him falls entirely the success or the lack of success which his store will have in selling short-wave receivers, for whether or not they stay sold is dependent upon his ability to show the customer how to operate them and obtain satisfaction from short-wave reception. Once he has thoroughly implanted this in his mind to the extent where no amount of pressure will tend to alter his opinion of its importance, he may consider the more conventional servicing aspects of short-wave and broadcast band superheterodynes.

WANTED

\$20 to \$35 a week men who want to earn \$50 to \$75 a week and more

TODAY—more than any time before in the history of the great Radio Industry—Manufacturers, Broadcasting Stations, Sound Picture and Television concerns, and others—are on the lookout for men capable of being promoted to their more responsible jobs.

They can get all the men they want for their ordinary work—jobs that pay \$20 to \$35 a week or less. Which, of course, is one reason why these jobs don't pay better wages—almost any man can do the work.

But for their better-paying jobs—those jobs that pay \$50 to \$75 a week and up—well, it's different. Here brains, not muscle, are required. Here knowledge, not guess work, is necessary. Here men capable of some day being promoted to still better-paying jobs are needed.

This big demand for men of this type has been brought about by the amazingly rapid expansion of the Radio field. Because of dozens and dozens of new, and almost revolutionary, developments, hundreds and hundreds of big-pay jobs have been created almost over-night.

Radio work is no longer limited to the building and servicing of Radio sets.

It now includes such other things as Sound Pictures, Public Address Systems, Radio in Industry, Radio in Aviation, Radio aboard ship (for operating mechanisms of different kinds, and even for running the ship itself), telephotography, Television, etc.—everything, in fact, that makes use of the vacuum tube or photo-electric cell.

Radio devices, today, are operating great machines formerly operated by man—are grading by color or size such manufactured articles as cigars, paper, silks, etc.—are counting people or automobiles as they go by any given point—are turning on and off lights in our big factories or on our city streets—are operating airplanes in the air—directing ships at sea from stations on land—creating music more perfect than played by our best masters—and doing a thousand other things not dreamed of a few years ago.

To know Radio is to know the principles of all of these things.

And to such men the great Radio Industry offers many wonderful opportunities—steady work at good pay, NOW—and an early advancement to still better-paying jobs, as a future.

But no ordinary knowledge of Radio will do. To qualify for these better-paying jobs—men

must know the theory and practical application of all Radio devices—old and new, and they should be able to teach other men some of the things they know.

That means they must be "trained".

As few men can afford to get this training at some College or University, the Radio and Television Institute, of Chicago, was organized to train men at home—no matter where they live—in their spare time—easily and quickly—and at a cost of only a few cents a day.

The Radio and Television Institute is the ONLY Institution of its kind whose Course of home-training is actually supervised by an Advisory Board of outside business men,—all highly paid engineers and executives,—each actively connected with some large Radio concern. It is, too, the ONLY Radio School to be endorsed by some fifteen of our largest and most progressive manufacturers of Radio and Television equipment. These public endorsements were given to guide ambitious men who seek a future in Radio. These manufacturers want all such men to know that the Radio and Television Institute has their unqualified approval, and their hearty support, in its work of training men, through spare-time home-study, for the many better-paying jobs that exist today in Radio . . . Sound Pictures . . . and Television work.

Radio and Television Institute home-training prepares men, easily and quickly, for these better-paying jobs. It is the ONE recognized connecting link between ambitious men and a splendid future in Radio.

To the man, then, who is earning \$20 to \$35 a week NOW—and who would like to earn \$50 to \$75 a week or more—regardless of whether or not he is doing Radio work today—we say in all honesty—"we think we can help you." Just mail the coupon below for full particulars of our plan and a free copy of the new Opportunity Book.



Radio—first an experiment—then a plaything—now a giant industry—the fastest growing industry the world has ever known—offering thousands of wonderful opportunities to ambitious men.

✧ RADIO AND TELEVISION INSTITUTE ✧
DEPT. 6Y 2130 LAWRENCE AVENUE, CHICAGO

Please send me a copy of your Opportunity Book and full particulars of your plan for helping men into good pay positions in the Radio field.

Name.....

Address.....

City..... State.....

RADIO-CRAFT KINKS

THE RADIO-VIOLIN

By Fess Christiani

RADIO programs may now be received through the medium of the violin. Find the center of a small magnetic speaker disc, and solder a small wood screw to it at the center. Then cut a wooden violin mute as

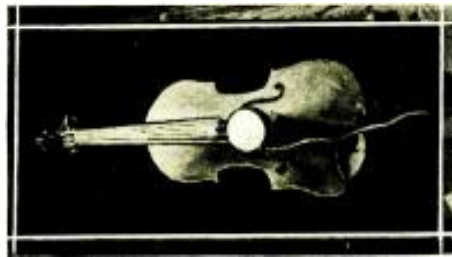

Fig. A

The radio-violin. The improvised speaker unit on the violin bridge, facilitates radio accompaniments.

shown in Fig. 1 and screw it to the speaker diaphragm. The telephone unit is now assembled together with the mute and the entire arrangement attached to the bridge of a violin as shown in Fig. A.

When a program comes over the radio, one may have the novel experience of walking about the room accompanying it. I play an obligato, and the tone is very clear. There is a great "kick" in it for both listener and player.

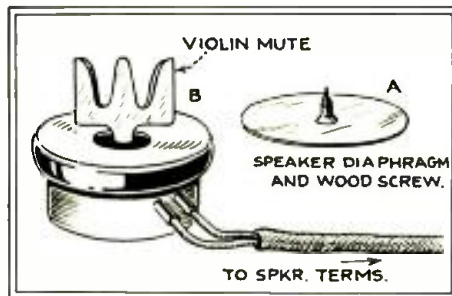

Fig. 1

A home-made mute is screwed to a speaker diaphragm.

IMPROVING RECEIVER OPERATION

By George Stoneham

THOSE service men who wish to improve the operation of the seven tube Federal Orthosonic receiver at a very low cost, may make the changes outlined below which resulted in a decided improvement in operation over that received prior to making the change.

This receiver uses the BA Raytheon tube for rectification, and, consequently the slightest change in line voltage manifests itself in corresponding changes of the filament voltages and current of the '01A tubes whose filaments are connected in series. By substituting two '80 tubes for

the Raytheon as shown in the diagram of Fig. 2, the hum experienced with the old mode of connections entirely disappeared and excellent stability of operation was secured.

The five volt winding for the pilot lamp is used to supply the filament of the '80's and there is sufficient room in the power unit to house the two new tubes. The cost of the additional parts necessary for the change is negligible compared to the increased satisfaction secured.

Incidentally, if a small coil, tapped in the center, that will match the tuning condenser is used in the first stage instead of the loop, and is connected to a short aerial, an increase in the selectivity and distance received will be noted.

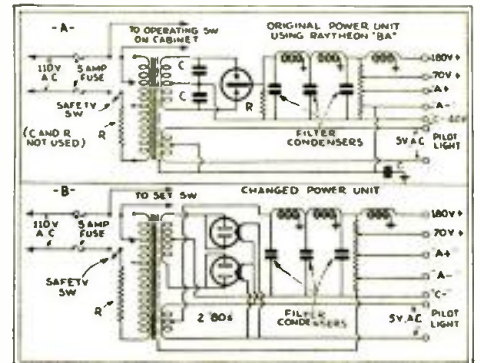

Fig. 2

By replacing the B.A. Raytheon with two '80's, the operation of the Federal Orthosonic receiver is much improved. The three condensers marked C and the resistor R, which are used in the original circuit, are not needed after the unit has been repaired as shown.

USES OF THE TEST PROBE

By Jos. Riley

TECHNICIANS breaking in to the service field may be interested in knowing the uses to which the simple test probe (illustrated on page 275 in the November issue of RADIO-CRAFT) may be put. As stated in the issue referred to, the probe is small, extremely handy, and should find a place in the pocket of everyone who tests a radio receiver.

(1) Open Circuited By-pass Condensers

If a receiver oscillates, or has excessive hum, remove the lamp from the probe end, attach the test probe clip to the chassis, turn on the set, and touch the high voltage end of all the by-pass condensers. The set will perform normally when the faulty condenser is touched. This is illustrated in Fig. 3A.

(2) Short Circuited By-pass Condensers

Insert the standard lamp in the probe, connect a 4½ volt battery in series with the clip lead, connect the other end of the battery to the chassis of the receiver, and touch the probe point to the opposite ter-

Readrite
No. 550

OSCILLATOR

(Licensed by A. T. & T. Co.)

\$18 Net to dealer \$30 list
\$21 Net to dealer with output meter

If not at your Jobbers, we will ship direct when remittance accompanies order.

A sturdy modulated instrument carefully made. Completely shielded with separate battery compartment. Furnished with 22½-v. and 3-v. batteries. Uses one '30 tube. Covers broadcast band (550-1500-k.c.) and intermediate band (120-185 k.c.). Operating instructions attached in case cover with shielded wire leads. Very compact. In leatherette case, 6 x 11½ x 5½ in. Weighs but 8 pounds. Built to high standards.

Every serviceman should have the No. 550 oscillator to align r.f. gang condensers, locate defective r.f. transformers, adjust i.f. transformers, check oscillator stage and determine sensitivity of a receiver. A necessary instrument. Get yours today. Write for catalog of servicing instruments.

Readrite Meter Works

Established 1904

17 College Ave., Bluffton, Ohio

minals of the condensers. A shorted condenser is indicated by the lighting of the lamp to full brilliancy.

(3) Testing Tuning Condensers and Coils

Turn off the set. Connect a 4½-volt battery in series with the probe and the chassis. With a standard lamp in the test probe, touch the probe to the grid end of the R.F. coil. The lamp should light at half brilliancy. The tuning condenser should then be rotated and if at any point the lamp jumps to full brilliancy, then the condenser is shorted at that point. See Fig. 3A.

(4) Aligning Tuning Condensers

Turn on the radio set, start the test oscillator and tune it in. Attach the test probe clip to one terminal of the voice coil of the speaker and touch the probe point to the other. (A few sets will require connecting

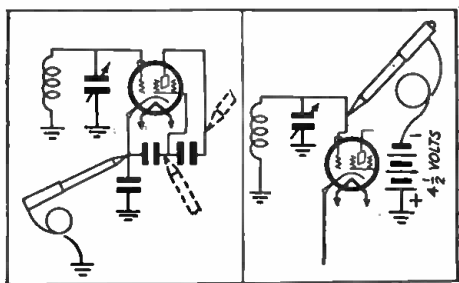

Fig. 3

At the left, A, locating shorted by-pass condensers; at the right, B, testing tuning coils and condensers.

the tester in series with the voice coil, rather than in parallel with it.) Adjust the volume control for minimum brilliancy of the lamp. Then adjust the individual tuning condensers for maximum illumination. This operation should be repeated several times.

(5) Checking R.F. Coil Polarity

Connect the tester to the set as described in (3). With the lamp at one-half brilliancy, place a small magnetic compass beside the probe and note the direction of the pointing needle. This should be repeated for every other R.F. coil; the compass should point in the same direction in all cases.

(6) Checking High Voltage

For making voltage or current tests beyond the means of the tester, the standard lamp may be removed and a neon lamp inserted in its stead. Using this arrangement every high voltage point in the receiver may be tested with ease.

(7) As a Trouble Lamp

By directly connecting a 4½-volt lamp across the terminals of the probe, it may be used as a very handy trouble lamp for examining the chassis of radio sets.

(8) Miscellaneous

By replacing the standard lamp with one rated at 6 volts, complete continuity of the ignition system in an automobile may be easily and conveniently checked. The clip is attached anywhere on the chassis of the car and the probe touched to the "high" side of the lamps. The lighting of the lamp indicates the presence of voltage.

Continuity tests may also be made by connecting the probe as described in (3).



"I SERVICE HUNDREDS OF SETS EASILY WITH THIS RESISTOR GUIDE"

"I would not give up your Resistor Guide for ten times the price I paid for it. It is my constant companion and saves me many hours of guess work. I service hundreds of sets easily by using the Guide, with greater income as a result of it."

(Name on request)



This statement from a serviceman's letter, one of hundreds mailed to us, goes to the root of the resistor problem in repair work.

The I.R.C. Guide is a remarkable *time saver*. It is a short cut to trouble finding. You are through with one set and on to the next in one-tenth the time it would otherwise take.

The reason? This book gives the value and code of each resistor, and its position in the circuit, of nearly every popular make of radio receiver. More than 200 circuits listed.

The busiest season of the whole year in radio is here. Be ready to get and handle your share of the business. Over 8000 servicemen use the I.R.C. Guide. Write for your copy.

INTERNATIONAL RESISTANCE COMPANY
Philadelphia - - - Toronto

FREE with Metallized Resistors

With the purchase of 10 I.R.C. Metallized Resistors, from any wholesaler, you will receive the Guide free—or it may be bought for \$1. Loose-leaf sheets, mailed to you periodically without charge, will keep it constantly up to date. Mail the coupon today.

Makers of



Metallized

RESISTORS

INTERNATIONAL RESISTANCE CO., C-12
2006 Chestnut St., Philadelphia
Gentlemen: (Check offer you are interested in)
 I enclose \$1.00 for Replacement Guide.
 Please send price list of Metallized Resistors. I wish to purchase assortment of ten, which will entitle me to Resistor Guide Free.
NAME
ADDRESS
CITY.....STATE.....

ACROCYCLE OSCILLATOR



A self-contained miniature transmitter with dial calibrated in kilocycles. Any frequency between 115 K. C. and 1680 K. C. can be easily produced accurately. Indispensable for aligning Super-Heterodyne receivers with intermediate frequencies of 130-175-260-475 K. C. and all others. List Price \$30.00. Service men or dealers, Net Price \$17.50. Leatherette carrying case extra, Net \$2.00. Tube and batteries extra, Net \$2.33. If your jobber does not carry, order direct. Sent express collect or C. O. D. with a deposit of \$1.50.

This instrument made by the manufacturers of the SUBMARINER SHORT WAVE ADAPTER now priced at \$12.50.

ORDER TO-DAY

J-M-P MFG. CO., INC.
3350 Fond du Lac Ave.
Milwaukee, Wisconsin, U.S.A.
Cable Address: "SUBMARINER"

The Radio Craftsman's Page

RADIO-CRAFT SET "STEPS OUT"

Editor, RADIO-CRAFT:

Yes sir, the two tube A.C. Pentode sure is a loud little set! I had constructed a three tube transformer coupled receiver using a '24, a '27 and a pentode when your article came along. Taking out the audio stage and rewiring it according to your diagram, I find that the DX that this little set brings in during the daytime is unusual.

My primary coil is $1\frac{3}{4}$ in. in diameter, has 10 turns and is wound over the ground end of the secondary. The tickler has 20 turns, the plate circuit is by-passed with a .00035-mf. condenser, and regeneration is secured by means of a 25,000 ohm potentiometer. I find that a 250,000 ohm grid-leak in the first stage and a 2 meg. leak in the second stage add to the volume.

I picked up a government "ditty" box which is just the right size for the job. I also find that when the regeneration control is advanced, the set makes a good oscillator around the shop, giving a strong clean signal. Selectivity is fairly good on a 140 foot aerial, and with a 10 foot lead connected to the antenna post, the volume is fair on locals with no interference from adjacent stations.

I am going to try a stage of S.G. ahead of the detector to try for better volume, DX, and selectivity. If someone would make a 2 volt battery about 6 in. on each side, it might be excellent for use with a two or three tube portable set.

To get back to our set, it surely is surprising what it will do. I wish you had published one about three months ago, for then I would have had a portable on my vacation.

D. VERNE CHAMBERS,
543 W. 146 St., New York.

A PRIZE WINNER

Editor, RADIO-CRAFT:

You can't imagine my surprise when your letter finally reached me way out here after being forwarded from Norfolk, my home.

And the contents of it simply thrilled me! I could hardly believe my eyes. I just wanted to thank you very, very much. After reading your letter I rushed down to a news-stand to get the September issue of RADIO-CRAFT, but what a time I had trying to find one—every place had sold out.

From now on I shall never miss it, and shall give it more of my attention because of your consideration of me.

MRS. KARL NASH,
502 South 3rd Street, San José, Cal.

(Mrs. Nash was the winner of the second prize of a contest conducted by RADIO-CRAFT some months ago. The contest was conducted in order to determine the best three names for both professionals and non-professionals in the sound field. The winners were announced in the September issue of RADIO-CRAFT).

AN EXPERIMENTER'S VOICE

Editor, RADIO-CRAFT:

Presenting my view, please allow me to state that I think it is about time something was mentioned regarding the radio experimenter, such as was discussed in an editorial in RADIO-CRAFT some time ago.

I have my own set amplifier and phonograph, and my interest lies in the "Midget" receivers (not short waves at all). Yes indeed, the experimenter moves along with science and gets more of a "kick" from it than those that depend upon it for a living, and furthermore he can conduct his studies for less cost than the Service Man. I said Service Man—any experimenter, of course, who has his own ohmmeter, set analyzer, oscillator, etc., can be one, but to really study the design of coils, etc., and advance with science, one must be an experimenter.

FRANK DEMARCO,
63 Oak St., Yonkers, N. Y.

Paste This Label into Your Radio

IF THIS RADIO STOPS
CALL
Cumberland 6-4060

FOR
REAL RADIO SERVICE
550 State St. at Flatbush Ave. Brooklyn, N. Y.
Prompt Service—Always Open—Including Sunday

An "inside the set" paster.

RE. THE WATSONGRAPH

Editor, RADIO-CRAFT:

As one of the engineers who are working on the development of the "Watsongraph" Wireless Typewriter, described on page 74 of the August issue of RADIO-CRAFT, I wish to bring to your notice an error appearing in one of the circuits; this error was made by me, when I made the original drawings.

The Thyatron circuit shows the grid bias on the transformer side of the grid condenser, instead of on the grid of the tube. Please accept my apologies for this error, which is without doubt my fault.

The fact that these tubes are gas filled does not change the grid circuit action in the least, the input circuit being practically the same as that of the standard three electrode vacuum tube. An examination of the circuit as sent to you, and published in RADIO-CRAFT, will show that the grid bias battery and grid resistor tend to short-circuit the secondary of the input transformer, while the grid of the tube, having no bias, is in a very sensitive and unstable condition. Therefore, if the lead from the grid of the tube to the grid condenser is very long, and parallel to circuits carrying audio currents, including the sixty cycle used to heat the filament of the tube, the tube will have a tendency to ionize, even when no signal is impressed on the primary of the input transformer.

S. J. STANSFIELD,
150-15 Sanford Ave., Flushing, L. I.

Make a
PROFIT

On Every Service Call
Easily installed in 5 minutes. Write Dept. RC-12 for money-making proposition.

AMPERITE Corporation
561 BROADWAY, NEW YORK

AMPERITE
Self-Adjusting
LINE VOLTAGE CONTROL

VARIABLE RESISTORS

Interesting Facts About Volume Controls

By DR. L. VAN DER MEL, PH.D.

IT is a relatively easy matter for a Service Man to calculate the proper size resistor to use in a power pack or in a grid circuit if the voltage across and the current through the resistor are known. But when the problem is to determine the correct size and type resistor to use as a volume control across a transformer, the Service Man is usually at a loss to know just what factors to take into consideration in order to arrive at a definite conclusion.

The ordinary procedure is to try several sizes, and finally select the one that gives the most uniform variation in response. Needless to say, the results of this method are based on the ability of the Service Man to guess accurately and not on his technical knowledge, consequently the "heuristic" method of solution is not recommended.

A resistor shunted across the secondary of a high impedance transformer should satisfy four requirements. First, with equal increments of the dial setting, uniform varia-

tion of the final output should be obtained; second, the effect of the addition of the volume control on the impedance of the circuit should be negligible; third, the movement of the sliding contact over the resistance element should be noiseless from both a physical and an electrical standpoint; and fourth, the resistance should not draw so much current that it will burn out.

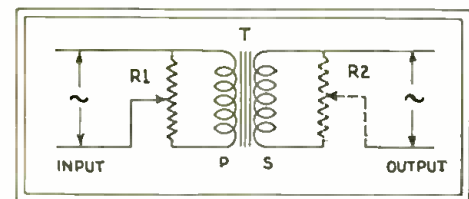

A volume control resistor may be placed across either primary or secondary, depending upon their impedance

To overcome the first problem, the resistance element should be calibrated "logarithmically," or in other words should be tapered. The reason for this will be apparent when it is realized that the ear does not respond uniformly to uniform increases in sound power. If, let us say, 10 milliwatts of sound energy produces a certain amount of "loudness," then 20 milliwatts will not produce a signal twice as loud. The degree of increment in loudness is proportional to the logarithm of the change in power. In order then, that the ear recognize uniform sound increases, it is essential that the change in voltage to a tube vary in such a manner that the final output will vary in a smooth manner. Reliable manufacturers of volume controls really design their units to faithfully follow the logarithmic law.

The proper size resistor to use depends almost entirely on the impedance to which it is to be connected. If it is too low, it alters the impedance of the line, draws excessive current, eventually gets noisy, and the variation in output is large for small changes in the volume control setting. If, on the other

hand, it is too large, the impedance of the line will not be upset, it will not draw excessive current, will not get noisy so easily, but the volume will be crowded on one end of the unit which really means non-uniformity of response. From the foregoing it can easily be appreciated that the choice of the proper resistance is very complicated from a mathematical standpoint, in fact mathematics is seldom resorted to in practice for such computations. Theory indicates, and experiment verifies, that the resistance volume control should be from 10 to 15 times the impedance it is to be connected across as shown in the figure. Values between these limits have none of the disadvantages outlined above, and when properly tapered result in very satisfactory results.

Obviously, the "hitch" in the problem is to know the impedance of the transformer across which it is to be connected. To assist the Service Man in determining the proper size volume control to use in present day circuits, the Central Radio Laboratories have prepared a handy little booklet which gives not only the R.F. and A.F. circuits in which volume controls are used, but lists numerous radio receivers and states the values of variable resistors used. This booklet is discussed elsewhere in this issue.

"HOW THE INTERNATIONAL RESISTANCE COMPANY CAN BE OF MORE SERVICE TO THE SERVICE MAN"

THE above is the subject of a contest carrying a total cash prize award of \$175.00 in the following denominations: First prize, \$100.00; second, \$50.00; third, \$10.00; fourth, fifth, and sixth, \$5.00 each.

The rules to be observed are as follows: (1), Contest is open to all owners of the I.R.C. Service Man's Resistor Replacement Guide; (2), All letters must mention the designation mark on one of the metal ends of this year's "K"-type metallized resistor (last year the mark was the letter X); (3), All letters must be typed, and less than 200 words; (4), Members of the I.R.C. organization are not eligible; (5), Tying contestants each will receive the full amount of the award. The closing date of the contest is December 1st.

Rhetoric and phraseology are of no consideration; what is wanted are *ideas* which will enable the International Resistance Company, Philadelphia, Pa., to be of more service to the thousands of radio Service Men in the field.

AUTOMOTIVE TUBE LIFE

RECENT tests on Sylvania automotive tubes of the 6.3-volt filament, cathode-heater type, indicate the average life of 1,000 operating hours may be obtained if the filament potential is kept within the limits of 5.5 to 6.5 volts.

WHICH BRANCHES OF RADIO

DO YOU PREFER?

Aircraft Radio ... Broadcast Station or Studio ... Direction Finder and Radio Compass ... Talking Pictures ... Film and Disc Recording ... Servicing Home Entertainment Equipment ... Television



Learn Them at

RCA INSTITUTES, Inc.

New developments ... new inventions ... new problems come almost every day in the radio industry. Yet only the well-trained man can hope to win. Prepare yourself!

For no other purpose than to train and equip men of unusual promise ... RCA Institutes, Inc. maintains four complete resident schools in New York, Philadelphia, Boston and Chicago. They are the only schools associated with the largest, most complete research laboratory in the radio industry.

These schools offer elementary and advanced courses, based on 22 years experience, in practical radio. See list in coupon below. New courses added, old ones constantly revised as new developments are perfected.

Win Radio Scholarship from RCA Institute

If you cannot attend the resident schools, RCA Institutes Extension Courses enable you to study at home. Special laboratory equipment furnished. Outstanding graduates of home free courses become eligible for one term free scholarship at nearest resident school. Cost of either extension or resident study moderate. Will you become a vital part of a great and thrilling industry? Write for details. The coupon makes it easy.

RCA INSTITUTES, Inc.

RCA Institutes, Inc., Dept. NP-12,
75 Varick Street, N. Y.

Gentlemen: Please send me your General Catalog. I am checking below the phase of radio in which I am particularly interested.

<input type="checkbox"/> Aircraft Radio	<input type="checkbox"/> Disc and Film Recording
<input type="checkbox"/> Broadcast Station or Studio	<input type="checkbox"/> Servicing Home Entertainment Equipment
<input type="checkbox"/> Talking Pictures	<input type="checkbox"/> Direction Finder and Radio Compass
<input type="checkbox"/> Direction Finder and Radio Compass	<input type="checkbox"/> Television

Name: _____
Address: _____
Occupation: _____ Age: _____

Make Depression Pay!

Take advantage of the present demand for repair of old receivers! Build strongly for the future, and increase your business by giving GUARANTEED REPAIRS.

You can do this safely by using Radio's Finest Parts—

POLYMET PRODUCTS

Standard of the Industry

FOR FILTER BLOCK REPAIRS THE POLYMET KIT of 25 UNCASED CONDENSER SECTIONS illustrated below—is the most useful Kit ever assembled for service work. Many capacities and sizes, all in strict accordance with R.M.A. ratings.

Mail the Coupon for special low-price introductory offer. It will also bring you the new 1931 Polymet Parts Catalog, containing many service helps.



POLYMET MFG. CORP.
829 East 134th St.
New York City.

Send me your sensationally low-priced introductory offer on the Polymet Condenser Repair Kit. Also include the new 1931 Polymet Radio Parts Catalog, without charge.

Name _____
Address _____
City _____
State _____

Mark Proper Square

- JOBBER
- DEALER
- SERVICE MAN
- CUSTOM SET BUILDER

HEADQUARTERS for all RADIO SERVICEMEN'S SUPPLIES

We carry the largest supply of replacement parts and general radio parts in the mid-west. Our store is the rendezvous for radio servicemen who will always find the latest and the best in radio merchandise in stock. We specialize in replacement transformers, condensers, resistors and volume controls for all makes of radio sets.

Be sure to drop in and see us when you are in Chicago.

NEWARK ELECTRIC CO.
A Radio Service Institution
229 West Madison St. Chicago, Ill.

Radio-Craft's Information Bureau

D.C. AND A.C. SHORT-WAVE SETS

(138) Mr. Ernestina Aponte, Caguas, Porto Rico. (Q.) I would appreciate your furnishing me with a schematic diagram of a short-wave set that I have whose wiring has been tampered with. I bought this set a few weeks ago and I have not been able to use it.

The set is a five tube affair using two '27's, a '24, a '71A, one '80 rectifier, and is of Aero make. It is housed in a metal container and is a single dial controlled set. I wrote to the Aero Products Co., Inc., for data on this set, but I understand that they have failed. I would also like to have the values of its component parts.

Last night I tuned to our local broadcasting station WKAQ. The set operated but the volume was very low and accompanied by distortion and an uncontrollable oscillation.

(A.) By virtue of purchase from the United States District Court of the receivers right, title and interest in and to the good-will of the Aero Products Company, Inc., The Chas. Hoodwin Co. are now the successors of the aforesaid Corporation.

A diagram of a four tube short-wave receiver has been supplied by the Chas. Hoodwin Corporation, and is indicated in Fig. Q.138A. Evidently the receiver of Mr. Aponte had been changed for A.C. operation. We show in Fig. Q.138B a schematic diagram of the same receiver redesigned for A.C. operation.

SAF FADER—SAF-3 MIXER

(Volume and Tone Controls)

(139) Mr. August Karlotten, Germantown, Pa.

(Q.1) What is the difference between a type SAF Fader and SAF-3 Mixer; both units being part of a sound movie installation? How are these to be wired into a sound system? Both units are manufactured by Simplimus, Inc., in Boston, Mass.

(A.1) The SAF Fader is a distortionless attenuator to be interposed between the head amplifier or disc pickup and the main amplifier, and serves to control volume in a "straight line" manner. Change-over to either disc or head amplifier is the duty of a two-way switch. Vitreous resistors

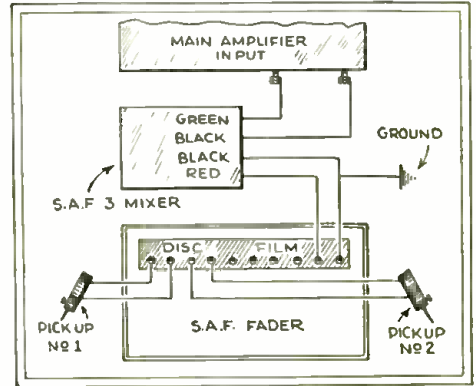

Fig. Q.139A

Connecting a sound amplifier, fader, mixer, and pickups.

are used, having the total value shown in Fig. Q.139B.

The SAF-3 Mixer is a tone-control device which is to be connected between the sound pickup device and the main amplifier shown in Fig. Q.139A.

The following detailed data is furnished by the manufacturer, and indicates that the mixer has application also in radio receiver circuits:

"As there are always two projectors in a theatre installation, the disc equipment includes two phonograph pickups, as shown in Fig. Q.139A. The sound-on-film equipment is generally made up of two photo-electric cells and two head amplifiers or preamplifiers; which are 2-stage units using a combination of resistance and transformer coupling.

"The selection or rejection of frequencies is obtained in the SAF-3 Mixer by control of inductance and impedance values, as shown in Fig. Q.139B.

"The 'equalizer' portion of the instrument is for the purpose of adjusting the impedance match of the input and output circuits. With the equalizer set at zero, no frequency correction takes place,

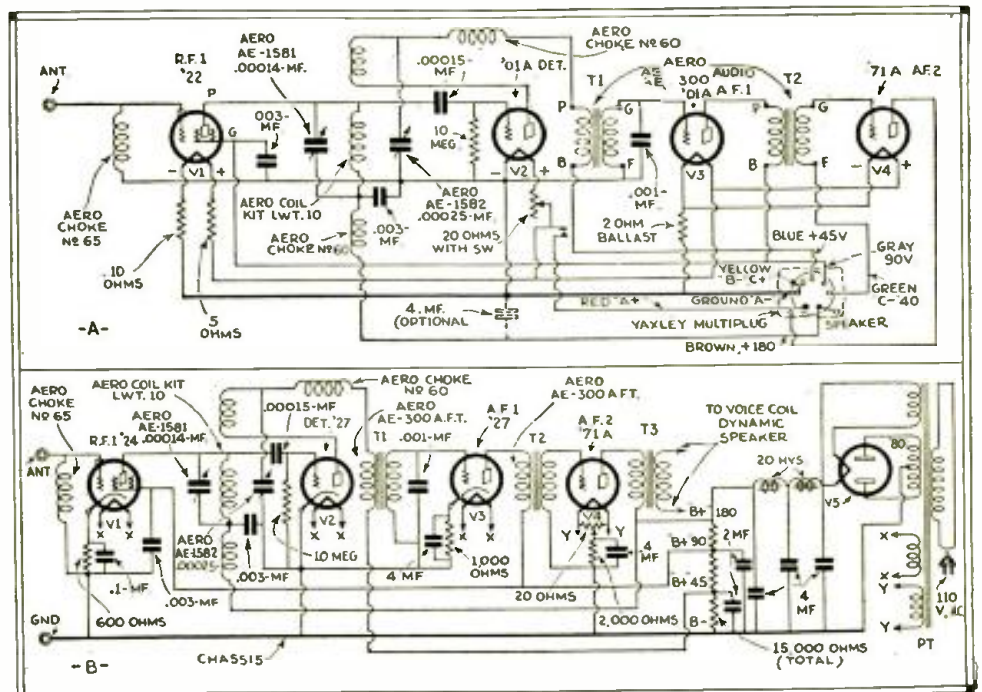

Fig. Q.138

At A, above, the original connections of the Aero Short-Wave Receiver; B, below, the same receiver adapted for 110 V. A.C.

no matter what the setting of the 'compensator,' as the impedance of the amplifier input is lower than the impedance of the pad.

"The 'compensator' controls the amount of low, medium, or high frequency cut-off.

"With the equalizer set at half-way or 5,000 ohms, any amount of the high, medium, or low frequencies can be cut out by adjusting the compensator. When the compensator is set at zero, maximum correction occurs; however, if it is necessary to secure more correction, the resistance in the equalizer circuit can be increased. For instance, with R1 set at 10,000 ohms, and R2 at zero, the frequency band passed by the impedance-

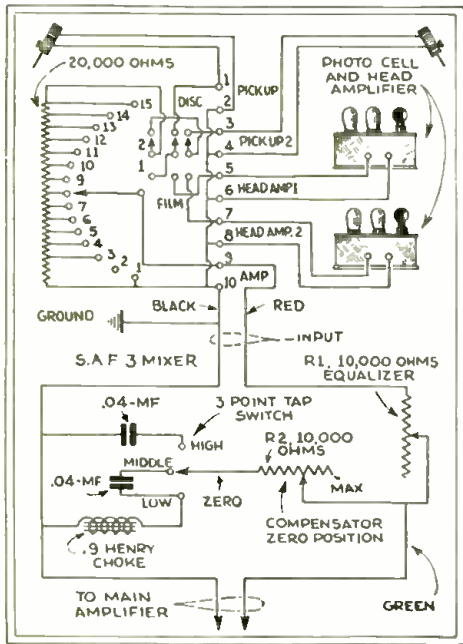

Fig. Q.139B

Constructional details of the S.A.F. tone control.

capacity combination will be greatly broadened. Now, by moving the 3-way selector switch to 'low,' 'medium,' or 'high,' only the low, medium, or high notes, respectively, will be by-passed through the impedance-capacity combination, resulting in only high frequencies being passed from input to output at the 'low' setting of the switch; low frequency selection at the 'high' setting; and in 'medium,' only the extremely low and extremely high notes will be by-passed."

This method of tone control is more convenient than the system described in "An Ideal Sound System for High Power," in the August 1931 issue of RADIO-CRAFT; although the tone correction has substantially the same graph as shown in Fig. 2 of the article. It is very convenient to apply to phonograph pickups and radio receiver output circuits, in addition to its use primarily in sound movie installations.

"PAM 19" POWER AMPLIFIER

(140) Mr. Ellis E. Jacobs, New Bedford, Conn. (Q.1) Please show in RADIO-CRAFT the schematic circuit of the Samson type "Pam 19" power

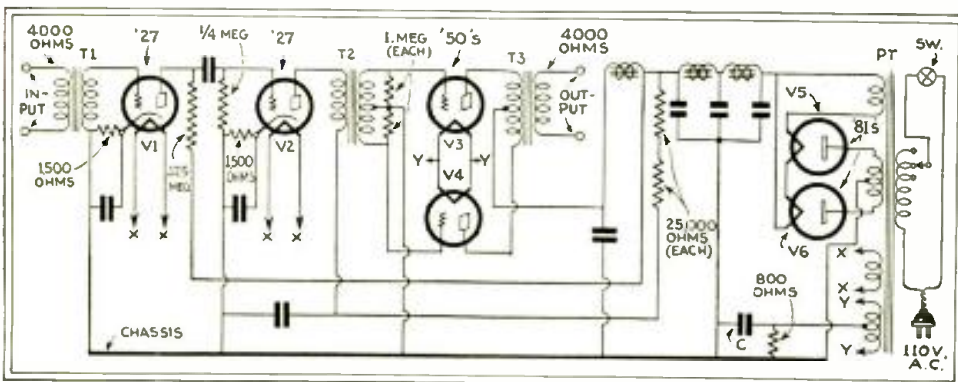

Fig. Q.140

Schematic circuit of the Samson "PAM 19" audio amplifier. Published by special permission of Cameron Publishing Co. Condenser C may not be required.

amplifier. It does not seem to be possible to obtain a circuit from the manufacturers, thus making it difficult to make repairs without going through a lot of checking of wires, measuring of resistors, and calculation for the unknown value of defective units. This amplifier uses two '27's, two '81's, and two '50's (the latter in push-pull).

(A.1) All available information on this power amplifier appears in Fig. Q.140. It is presumed that standard condenser values may be used in the positions for filter and by-pass action; the exact ones, however, have not been furnished by the manufacturers, to date. However, it may be convenient in some instances to obtain each condenser value from a perfect amplifier of the same type. Since Mr. Jacobs does not state the trouble he is experiencing, we cannot offer a diagnosis. It is necessary to use high-grade, high-voltage-test condensers in this amplifier, due to the fact that the potentiometer type of voltage divider, which puts a load across the power transformer until the tube filaments have had a chance to heat up and shut their load across it, is not used in the "Pam 19"; the standard or "slow heater" '27's requiring about 30 to 45 seconds to bring the plate current train to normal rating.

"SCHOOLS" REPORTED BY RADIO

ACCORDING to World-Radio, the little town of Aalesund has been the center of activities in the latest step taken by the Norwegian fishery authorities in an effort to net as many herring as possible during the six weeks of their season.

Experienced herring fishermen were assigned to two radio-equipped airplanes, which zig-zagged across a 200-mile labyrinth of fjords, bays, and inlets. As soon as a herring school was sighted, the fact was radioed to Aalesund, and from there relayed to the waiting fishing fleet, 15,000 fishermen and 2,000 motor-vessels.

Although each school contains millions of fish, it may not be sighted; and since a small season's catch may mean privation for thousands, the economic advantage of this application of radio at once becomes evident.

TROUBLE SHOOTING CONTEST

RADIO shows this year have been of particular interest to Service Men through the activity of Mr. Hathaway, Associate Editor of Radio Industries magazine, who instituted the idea of a "trouble shooting" contest.

A number of receiver classes are placed in individual booths, each chassis having its particular fault. The contestant progresses from booth to booth, being timed on each "job." All the instruments required for each series of tests are available in the respective booths. An A.C. power line in back of the booths is tapped to connection receptacles.

Lots of fun and keen rivalry exist at such get-togethers.

CROSLEY SUPERHETERODYNE New Pentode Output Variable Mu



\$36³⁶ Complete with Tubes

The Crosley LITLFELLA

See the NEW CROSLEY LITLFELLA—a 5-tube table model SUPERHETERODYNE radio receiver, incorporating big set features yet housed in an exquisite cabinet of choice walnut veneers, 17 inches high. Pentode output, variable Mu tube, full floating moving coil dynamic speaker, continuous (stepless) static and tone control, combined volume control and on-off switch, illuminated dial with vernier drive—such features as these make The Crosley LITLFELLA the greatest of all radio values. Only \$36.36 complete. Also the LITLBOY, a 35" lowboy model with same type chassis selling for only \$48.00 Complete with tubes

Push-Pull Pentode Output SUPERHETERODYNE



The Crosley PLAYBOY 8 TUBES

\$49⁷⁵ with 8 Tubes Complete

An exquisitely designed all wood compact table model, 17 inches high, housing the new Crosley 8-tube push-pull Pentode output, variable Mu, Superheterodyne chassis with latest type Crosley full floating moving coil dynamic speaker. Two five-element Pentode output tubes connected in push-pull; two variable Mu tubes; continuous (stepless) variable static and tone control; illuminated hairline shadow dial with vernier drive; combined volume control and on-off switch; full floating moving coil dynamic speaker. Priced amazingly low. Also console models. The CHEERIO at \$56.00. The MERRY MAKER at \$75.00, the ANNOUNCER at \$85.00, the PLAYTIME (Electric Clock Model) at \$95.00, incorporating the same type SUPERHETERODYNE chassis, complete with tubes. Never before such radio values!

Push-Pull Pentode Output SUPERHETERODYNE with METER TUNING AND Automatic Volume Control



The Crosley TENSTRIKE

\$69⁵⁰ Complete with 10 Tubes

An unusually attractive and powerful table model radio receiver incorporating the 10-tube push-pull Pentode output, variable Mu, SUPERHETERODYNE chassis with METER TUNING and Automatic Volume Control. Stump walnut veneer front panel with burr maple overlay. Top, sides and pilasters of walnut finish. Dimensions: 20 1/2" high, 16" wide, 10" deep. Also a magnificent six-legged console model with same type chassis at \$99.50 Complete with 10 Tubes

(Western Prices Slightly Higher)

THE CROSLEY RADIO CORPORATION
 POWEL CROSLEY, JR., President
 Home of "the Nation's Station"—WLW Cincinnati



THE NEW EMC Simplicity Test Probe Precision Made



As a result of the generous reception given the Simplicity Test Probe in this country and abroad, a startling reduction in price has been made. Increased production and new sales methods have made this possible.

The EMC "Simplicity Test Probe" for Service Men and Dealers fills a long-felt need for a fast and efficient testing device of vest-pocket size. Also, it is the lowest priced testing instrument of real value and quality on the market.

1. Locates open or shorted by-pass and filter condensers.
2. Locates burned-out resistors and wiring.
3. Checks presence of filament or heater voltage.
4. Tests continuity of all low resistance windings.
5. Checks correctness of tuning coil polarity.
6. Tests for breaks in tuning-coil windings.
7. Checks shorts in variable tuning condensers.
8. Gives visual resonance indication in aligning condensers.
9. Tests for high voltage and low current with neon tube.
10. Makes a very handy radio or automobile trouble light.

The EMC Simplicity Test Probe is made of a polished red and black dielectric material, neatly engraved in gold, and looks exceptionally attractive and professional. It is a real quality product built for a lifetime of service, and an instrument you cannot afford to be without. The Simplicity Test Probe is guaranteed and comes with standard lamp, eighteen inch cord, test clip, and complete instructions. The size is 7/16" x 7".

\$1.50
Net

testing instruments on the market today. The net price outside of the U. S. A. is \$2.00.

ELECTRICAL MANUFACTURING CORPORATION
10 High St. Dept. B Boston, Mass.

Study RADIO in CANADA



Marshall P. Bellis, service engineer, Sparto Radio of Canada, Limited, completed his radio training in our day classes. Mr. Bellis, who travels from coast to coast says: "Never in the history of radio has the demand for 100% trained men been so universal, and Radio College of Canada gives that training so necessary today."

Day, Evening and Home Study Classes

on practical radio design and construction, wireless telegraphy, mathematics and drafting. Instruction approved by leading radio manufacturers. Preparation for government examinations. Booklet on request.

Radio College of Canada
310 Yonge St., Toronto

The Balloon Radio

(Continued from page 333)

seen from the diagram, a '99 tube is used whose filament is lighted by means of a 4 1/2-volt dry cell which also actuates a small buzzer. This buzzer is of the transformer type having a turns ratio of 50 to 1, the output or secondary voltage of which supplies plate voltage to the tube. The oscillator circuit is the same as that used in the ordinary regenerative receivers, and consequently needs no explanation. The output of the set has no carrier since the plate voltage is interrupted at the same frequency as the buzzer, the result being a clean note that may be readily recognized by the receiving operator.

These units are tested immediately before being sent aloft. The buzzer frequency is adjusted until not more than 200 mc. are drawn from the battery; the antenna current then being nearly 30 ma. The method of releasing the balloons (clusters of four and six are used at one time) may be understood by referring to Fig. 2. The man at A holds the balloons while the man at B, having

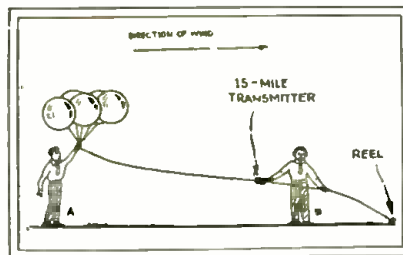

Fig. 2
Method of releasing the balloons with the 1 lb. transmitter attached.

tested the transmitter, attaches it between the legs of the antenna, the lower leg lying extended on the ground. The man at A then runs rapidly toward B, letting the antenna wire slide through his hands so as to allow the balloons to rise. Upon reaching B both men let go, allowing the balloons to rise without difficulty. This method of procedure has the advantage that sudden gusts of wind do not break one of the legs of the antenna, which may cause a loss of both the balloons and the transmitter.

Under favorable operating conditions, this transmitter may be heard for about 10 miles, and with a good battery (one that does not polarize easily) continuous operation for seven hours has been secured.

Method of Tracking Balloons

Of all the objects of these observations, the tracing of the path of the balloons is the only one desired at the present time. It is hoped that temperature recording may be incorporated in the tests in the near future. The method used is to inflate the balloons to a predetermined pressure, and with a knowledge of their ascension rates, calculate the elevation. The deviation of the balloon from a given starting point can then be determined by means of direction finders.

Briefly, a direction finder is nothing more than a sensitive receiving set using a loop-

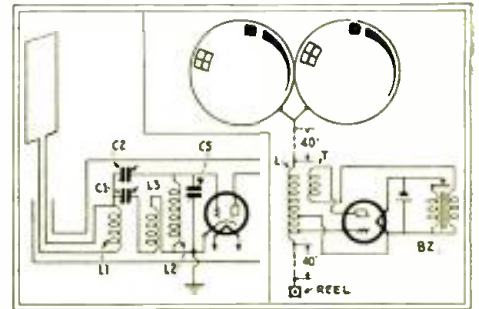

Figure 1, right. The diagram of the 1 lb. transmitter. **Figure 5, left.** The input loop circuit.

antenna. By using two such receivers, separated by a known distance, the loop of each set is focused on the transmitter. The planes of the loops are projected (on paper) until they intersect. The point of intersection is the location of the transmitter. This idea is depicted in Fig. 3.

The Receiver

The requirements of such a receiver are that it must be stable, easy of manipulation, sensitive, and free from capacity effects to ground. The circuit that was found to fulfill these requirements best, is shown in Fig. 4. The input or loop circuit is shown on an enlarged scale in Fig. 5. The condensers C1 and C2 are balancing condensers, and are adjusted so as to nullify any capacity effects of the input circuit to ground. These condensers are used together with the neutralizing coil L3. Very close coupling is used between L1 and L2 so as to secure maximum transfer of energy. The remainder of the circuit (Fig. 4) is merely a five tube receiver employing two stages of tuned R.F., a detector, and two stages of audio-frequency. Plug-in coils are used so that the receiver may be useful in bands other than that required for balloon tracking, which is from 1700 to 3300 kc. A photograph of the completed receiver, known as the Signal Corps type SCR-170 is indicated in Fig. B.

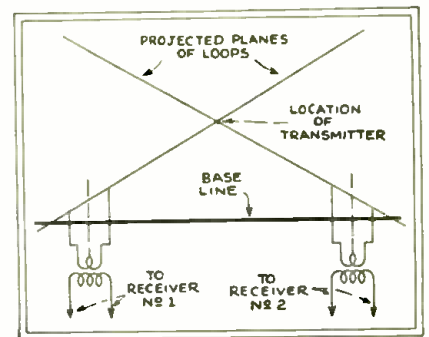

Fig. 3

The planes of two loops, situated on a base line, are rotated until the signal is a maximum. The point of intersection, as shown above, is the location of the transmitter.

LATEST in RADIO

(Continued from page 337)

a 22½-volt "B" unit, a dry-rectifier type of output meter, and a leatherette-covered-wood carrying case, 6 x 7 x 12½ in. high. Manufactured by J-M-P Mfg. Co.

RADIO SETS IN GERMANY

AS pointed out many times in past issues of RADIO-CRAFT, reception conditions throughout Europe are hardly to be compared with those in America. Line potentials and frequencies, wavelength ranges, tubes, operating hours, manufacturing facilities, and economic conditions,—each contributes its bit to modify the resultant radio receiver.

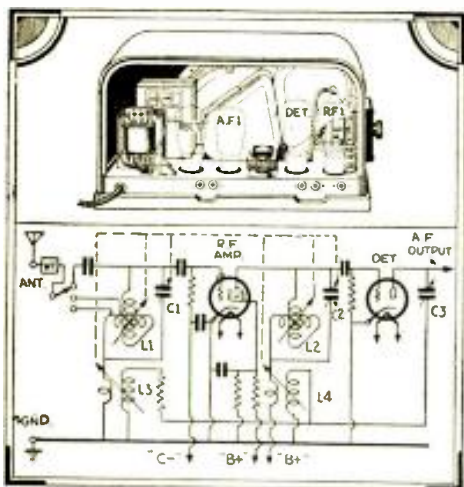

Fig. 5

The feature of this set, A, the wiring diagram of which is depicted at B, is the damping of the tuning condensers and variometers.

A comparison between the results obtained from the older theodolite method and the new radio method for plotting the trajectory of the balloon is tabulated in Table I. The results are based on the assumption that the theodolite method is correct.

An interesting photograph is that illustrated in Fig. C. The complete set-up in the field, together with the theodolites ready for operation, is very well shown. Its approximate size can be estimated by comparison with the soldier shown in the picture.

IMPROVED TESTING OF TUBES

IN the modern tube plant, we find an "audition laboratory." Here it is that batches of tubes are tested in a standard receiver. The input circuit connects to an indoor antenna and an A.F. modulated R.F. oscillator, while the output circuit is connected to an output meter.

Thus the following purposes are achieved: comparison of tubes in various makes and models of receivers, from the set owner's point of view; accurate measurement of *set and tube performance*; rapid analysis of the effect on performance of any proposed change in tube construction.

To cover the broadcast band of 200 to 2,000 meters, the firm of Siemens & Halske has developed the "Siemens 35" 4-tube receiver illustrated in Figs. D and 5. Outstanding is the manner in which this wide tuning range is obtained without recourse to tapped or plug-in coils or condensers, as shown in the schematic circuit, Fig. 5B, which illustrates the connections to only two of the tubes.

On the same gang control are feed-back couplers L3, L4, which are varied to maintain even regeneration throughout the tuning range. Regeneration in the detector circuit is controlled by variable condenser C3. Unit WT is a wavetrap. The compact layout is illustrated in Fig. 5A, and the handsome cabinet design, in Fig. D1.

Two T.R.F. jobs of Schaub manufacture, incorporating cabinet designs of exceptional merit, are illustrated in Figs. D3 and D4. A novel 2-tube "local" receiver of Telefunken make, is illustrated in Fig. D5; push-buttons permit coverage of the 200 to 2,000 meter band.

Finally, there is the interesting Saba receiver design illustrated in Fig. D2. The set incorporates tone control, manual volume control, and automatic volume control, in a T.R.F. circuit. The inclusion of the reproducer marks a recent advance in foreign set construction.

A BAND-SELECTOR UNIT

AS illustrated pictorially in Fig. E, and by diagram, Fig. 6, the Supertone Selector, or band-selector, may be connected to the antenna and ground binding

(Continued on page 377)

Min.	Theo. Bear.	Radio Bear.	Error
1	Missed	12	--
3	20.4	25	4.6
5	32.1	32	-0.1
6	37.5	34	-3.5
8	48.6	46	-2.6
10	61.8	62	0.2
12	75.5	72	-3.5
14	86.5	87	0.5
16	92.1	91	-1.1
18	98.9	98	-0.9
20	104.8	104	-0.8
24	124.6	124	-0.6
28	144.4	143	-1.4
32	164.2	163	-1.2
34	173.6	175	1.4
36	182.0	183	1.0
37	185.6	186	0.4
38	188.4	192	3.6
40	192.1	194	1.9
42	194.1	193	-1.1
44	195.1	195	-0.1
46	195.0	194	-1.0
47	195.0	194	-1.0
50	194.7	196	1.3
52	197.0	194	-3.0
56	202.5	199	-3.5
59	203.6	202	-1.6
60	204.8	205	0.2

By accident, he found out what every service-man wants to know

IF YOU had found your way into a certain laboratory last winter, you would have seen an earnest young engineer—buried in a maze of paper. Circuit diagrams, instruction books, service manuals of every important radio set maker for three years back . . . piled themselves on desk, chairs, floor.

What he was looking for doesn't matter. One thing he found became vitally important to every alert service man.

Out of 400—only 24!

By chance, this man noticed that certain resistance values appeared over and over again. He made a chart of them. It showed that out of the 400 odd-values in which resistors come . . . exactly 24 meet virtually every replacement call a service man is likely to have!

This interesting news led the Tilton Mfg. Co.—aided by a group of practical service men—to design the Ex-Stat service Kit. In compact, handy form, it contains one each of the "24 most needed values." With this kit—a service man *always* finds the resistor he wants—at his fingertips. Never does he make an extra, needless trip . . . never does he waste two hours in tiresome searching . . . all for a resistor worth a few cents.



New, handy Ex-Stat Kit containing "24 most used" resistor values.

Try this test:

Do you know what the 24 values are? Try this: Make up a list of your own—now. Compare it with the facts this engineer's research uncovered. To get his list, just clip the coupon below.

Not a cent to pay . . . you don't obligate yourself for a thing. But you *do* owe it to your own best interests to find out more about a way to save wasted hours . . . add to your earnings . . . keep a jump ahead of the crowd! So mark the coupon now—before you forget—before you turn this page.

TILTON MANUFACTURING CO.

15 East 26th St. New York

Headquarters for guaranteed, precision resistors, and Ex-Stat Ignition Filter Systems for auto-radio.

TILTON MANUFACTURING CO.
15 East 26th St., N. Y. (R.C.)

Send list of "24 most needed" resistor values, and details of Ex-Stat Kit for service men, to

Name _____

Address _____

City _____ State _____

New National 3 Tube S. W. Receiver

ACSW3 NATIONAL complete set of parts for 3-tube Short Wave Thrill Box—with band spread coils—less tubes—wired by the Jackson Research Laboratories.

Net \$31.00

Note: The above price is for either AC or DC models.

5880 POWER PACK FOR AC... Net \$19.00

Supplies of All Kinds for Short Wave Experimenters

CHICAGO RADIO APPARATUS CO.
415 So. Dearborn St., Chicago, Ill.
Est. 1921 Dept. RC-12

CLAROSTAT

POWER RHEOSTATS
for Transmitters, Speed Control, Line Voltage, Plating, etc.



2 Sizes: 80 and 250 Watts
3 Ranges:
1/4 to 10 ohms
25 to 500 ohms
200 to 100,000 ohms

CLAROSTAT
MFG. CO., Inc.
285 North 6th Street
Brooklyn, N. Y.

ALUMINUM BOX SHIELDS

Genuine "ALCOA" stock, silvery finish.
5 x 9 x 6, \$1.89—14 x 6 x 6, \$3.85, 10 x 6 x 7, Monitor size \$3.25, 5 x 5 x 5 (oil shield (like picture on right) \$1.00.



Any Size to Order.

"BUDDY" TEST PROD



Always sharp pointed, using phonograph needles, 4-ft. wires, spade or phone tips. Colored nipples identify each lead, \$1.50 pair.
We specialize in radio parts exclusively—parts furnished for any kit in any magazine, carrying cases for Set Testers, Analyzers, Portable Sets.

BLAN, THE RADIO MAN, Inc.
89 Cortlandt St. Dept. RC-1231 New York, N. Y.

ATTENTION DEALERS AND SERVICEMEN

Write now for our new 1932 Radio catalogue. Everything listed at lowest possible wholesale prices.

JOHNSON RADIO MFG. CO.
Tarrytown Rd. Pleasantville, N. Y.

MICROPHONES

SPECIAL NET PRICE LIST

No. 300	Single Button Carbon Type Stretched Diaphragm	\$ 9.00
No. 301	Two-Button Carbon Type Stretched Diaphragm	15.00
No. 302	Two-Button Heavy Duty Type	30.00
No. 303	Two-Button Compact Model	45.00

Also complete accessories for public address work
Write for Catalog

Miles Reproducer Co., 26 E. 22d St., N.Y.C.

BIG Reduction

in List Prices of

LYNCH METALLIZED RESISTORS

Now it will pay dealers and servicemen to STANDARDIZE on LYNCH Metallized Resistors. Write for details of RMA Color Code Chart and catalog showing new low list prices.



Metallized
1/2, 1, 1 1/2, 2, and 3 Watts

LYNCH MFG. CO., Inc., Dept. RC, 1775 B'way, N.Y.

R. F. COIL DESIGN

(Continued from page 339)

figure for 74 turns of this wire wound on a form 3 ins. (0.25-foot) in diameter equals 0.25 x 3.1416 x 74 = 58.1 ft.; therefore, the D.C. resistance of the coil (R) is 58.1 x .0214 = 1.24 ohms.

$$Z = \frac{.565 \sqrt{1,000,000}}{92.8} = 6.09$$

Then, by referring to the "F" curve in Fig. 2, F = 1.43; and from the "G" curve in Fig. 2, G = .948. The ratio of coil length

to the diameter is $\frac{2.25}{3}$ or 0.75 and, — that

is, referring to Fig. 3, K = 5.9; n = 74; d = 0.565, D = 3 inches or 76.2 mm.

From the above figures, the factor Knd = 5.9 x 74 x .565 = 1.62. When this fig-

ure is squared, the result is found to be 2.64. Then, R1 = 1.24 (1 + 1.43 + 0.948 x 2.64) = 6.11 ohms, which is the radio frequency resistance of the coil.

Finding Coil Inductance

Returning to the actual design of the coil, we find that the inductance must be determined.

This is readily calculated from the formula $L = \frac{W^2}{C}$, in which L is the inductance

$$3,553,225 C$$

in millihenries; W, the wavelength in meters; and C, the total capacity in microfarads (this really includes the capacity of the tuning condenser in parallel with the coil, the capacity of the coil itself, the stray capacities of the circuit, and the antenna capacity; for practical purposes, however, the capacity of the tuning condenser alone may be used).

The inductance of the coil must be calculated for both the maximum and the minimum capacity of the tuning condenser used. If the two calculations give the same figure, the result may be accepted as correct. If the value of inductance for the longest wavelength is smaller than the value for the shortest wavelength, the average of the two should be used; but if the inductance for the longest wavelength is greater, then the size of the tuning condenser is too small, and a larger size capacity must be substituted. Different sizes of C should be tried until the value of L is the same in both cases.

For a given value of inductance, the required number of turns is

$$n = \sqrt{\frac{1000 L}{SD}}$$

in which S is the shape factor shown in Fig. 3; and D, the diameter of the coil in centimeters. The results obtained by the writer for several sizes of coils from 2 to 3 inches in diameter are shown in the graphs of Figs. 4, 5, and 6. The curves of these figures are plotted for coils of three diameters; curve A, 3 ins., B, 2 1/2 ins., and C, 2 ins. The charts of Fig. 4 in each case (for different condenser capacities, as shown)

give the optimum or most desirable diameter of the wire in millimeters, and the corresponding size in B & S gauge. The charts of Figs. 5 and 6 indicate the comparative resistance of the windings, at 450 meters and 300 meters.

Wire Insulation

The optimum diameters indicated in these charts are for bare wire. If insulated, the covering may be used as a spacer between turns. The use of enameled wire, wound on a grooved form for spacing, increases the high frequency resistance about 20% over bare wire; with silk insulation as a spacer, the resistance is increased about 30%; and the use of cotton adds 40%, or more. Since the resistance which results when silk and cotton insulation are used is partially caused by moisture, it can be reduced somewhat by baking the coils and then coating them with amyl acetate, or some similar compound.

These charts show that the lowest R.F. resistance is obtained when the coil diameter is largest. Practical construction requirements, however, limit the coil to small dimensions, — especially if shielding is used. An increase in the diameter of the coil produces an increase in the size of the magnetic field and because of this, the shielding dimensions would require to be increased to impractical proportions. On the other hand, the R.F. resistance of the coil increases rapidly as the diameter is reduced below 2 inches.

Coil Dimensions

The writer has found that for broadcast frequencies, the lowest practical R.F. resistance is obtained when the length of the winding is about 1 1/4 times the diameter. The best all-round results were obtained in the experimental sets mentioned above with the coils about 2 1/2 ins. in diameter and a winding length of 3 ins. The shields were 7 ins. high, and sufficiently large in diameter to allow a space of 1 1/4 ins. on each side of the coils.

While the size of the shield cans described may be larger than those usually employed in receivers today, the difference in the operation of a receiver with the redesigned coils and sufficiently large shields in most cases will be a revelation.

When it is desired to determine the size inductance for only one or two coils, the most desirable, or optimum diameter for the wire may be determined by constructing a resistance curve similar to that shown in Fig. 1. After the formula has been solved for one diameter of wire, it is unnecessary to work out all the factors again, for each new wire size. The D.C. resistance of wire varies inversely as the square of the diameter: if the diameter is reduced to one-half, the resistance is four times its original value; and if the diameter is doubled, the resistance is reduced to one-quarter of the original value. From this it is readily seen that the new value of R in the formula may be very easily determined.

The factor Z in the equation varies directly as the diameter of the wire; it would be

The ANTENAPLEX

(Continued from page 339)

(grounding between one section of lead sheath and the succeeding section).

The base of this circular surface box is first secured in place on the wall or base-board by means of two screws, and the Cabloy sections are then cut to the proper length and trimmed for splicing and connecting. After the splices or connections are finished and insulated, the Cabloy is laid into the clamping ears, and the ears then crimped over, so as to grip the lead sheath. See

a flexible conduit, very much like the familiar "BX" in appearance, but is supplied empty,—that is to say, without any conductors inside. When making an installation of this kind, the ordinary type of flush or surface boxes should be employed, and suitable bushings should be applied at the ends of each section of the "Greenfield" where it enters the boxes.

Where it is desired to run the Cabloy on the external walls of buildings that are exposed to the weather, the procedure illustrated in Fig. 3 should be employed.

For existing buildings, the same procedure should be used for installing the central devices (Antensifier, Line Filter, Fused Switch, Lightning Arrester, etc.) as previously recommended for new construction work.

In addition to equipping individual structures with the Antenaplex system, it is also entirely practical to equip entire communities, such as a block of small apartments or dwellings. Thus, the tenants in a group of such buildings, who might otherwise be at a disadvantage due to electrical interference from a passing trolley line or some such source, may have the benefit of clear radio reception, by the installation of a "community Antenaplex system," with the central antenna remotely located, where it will pick up a maximum of the desired radio signals, and an absolute minimum of undesirable interference. If it is necessary to locate the antenna at a distance exceeding 500 feet from the radio outlets, an additional Antensifier unit should be employed at the 500 ft. point to act as a signal "booster."

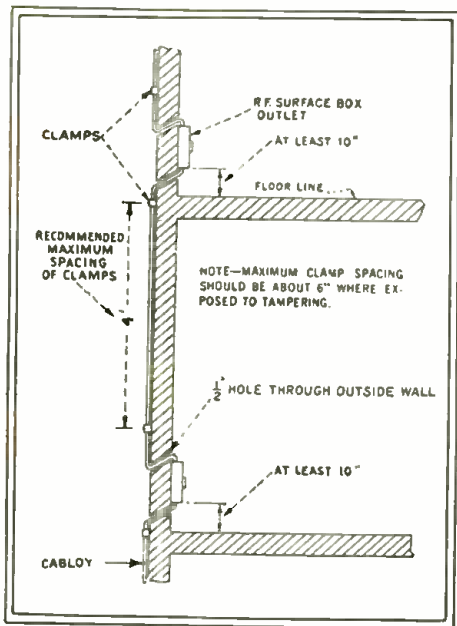

Fig. 3

The method to be used in mounting Cabloy on the external walls of buildings.

Fig. J. The tablet is then dropped into the cover, from which the corresponding "twist-outs" have been removed, and the cover is fastened over the base by means of the two screws supplied for the purpose.

In existing buildings it is not customary to employ conduit for the system, although if it is desired to add this precaution in the interest of best practice, "Greenfield" may conveniently be employed. This product is

doubled if the diameter were doubled. The new values of F and G in the formula may be read from the new figure for Z. The

factor $\left\{ \frac{Knd}{2D} \right\}^2$ in Butterworth's equation

varies directly as the square of the wire diameter; thus if the diameter were reduced to one-half, the factor would be one-fourth.

Plotting a Curve

By guessing the likely optimum value for the wire size, then working out Butterworth's formula for this value and, finally, varying the factors in the formula for two or three different sizes of wire both larger and smaller than the original, a sufficient number of points may be secured with which to plot a curve similar to Fig. 1. The lowest value of R.F. resistance will then indicate

the most suitable size of wire to use.

When selecting the wire size from the curve thus constructed, it is advisable to use a wire gauge only slightly larger than the optimum. The reason for this statement is the fact that although the resistance is increased only slightly, the self-capacity of the coil is increased noticeably, thus causing an increase in the coil losses. The increase in the self-capacity also increases the minimum wavelength to which the circuit will tune, necessitating a reduction in the number of turns on the coil.

In conclusion, it might be stated that the charts of Figs. 2 and 3 have been checked by the figures obtained from a number of coil samples tested with a vacuum tube voltmeter. They were found to be accurate within the stated limits.

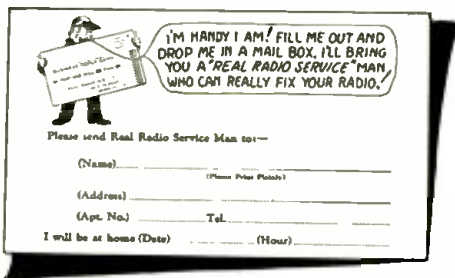

get this book!

worth its weight in gold !

NO serviceman, amateur or experimenter can afford to be without it. Gives complete volume control data, showing how to service most old and all new sets with a tiny stock of CENTRALAB REPLACEMENT VOLUME CONTROLS.

Comprehensive index lists hundreds of sets with all the dope on each set.

Also gives important information on Controls for

TONE CONTROL
 MULTIPLE SPEAKER SYSTEMS
 PUBLIC ADDRESS
 INSTALLATIONS
 AND FIXED RESISTORS

Send today for this important, well-illustrated book. Now in its third edition.

Centralab
CENTRAL RADIO LABORATORIES

930 E. Keefe Ave., Milwaukee, Wis.

Mail the Coupon Today

CENTRAL RADIO LABORATORIES
930 E. Keefe Ave., Milwaukee, Wis.
Enclosed please find 25c for which send me your new VOLUME CONTROL GUIDE.

Name _____

Address _____

City _____ Province _____
Radio-Craft

Speech Input Equipment

(Continued from page 341)

meter and as most meters have different values, a definite resistance for the shunts cannot be realized until the meter resistance itself is known. This will usually be quite low and the shunt resistance is designed to carry 10 times the current through the meter. In other words, if the meter reads 15 milliamperes, then only 1.5 milliamperes is actually passing through the meter and 13.5 milliamperes are going through the shunt.

An easy method of calibrating the meter is to temporarily use a 0-15 or 0-20 milliamperemeter in series with either side of the microphone and in this way check the reading of the 0-5 milliammeter and shunt. The value of the shunt resistance can be varied until the proper value of current reading is obtained.

In operation there will not be any noticeable disturbance when the meter is connected across either shunt.

Condenser Microphones

If a speech amplifier is constructed along these lines with microphone current taken as described above, excellent results should be obtained. However, it would perhaps be well to indicate methods of designing equipment for handling condenser microphones.

As mentioned in previous articles, the public address system in the New Yorker consists of modified Western Electric apparatus, in that the amplifiers were redesigned for remote control. In this system there are two channels, each of which includes five stages of push-pull and by inter-connections it is possible to obtain an almost inconceivable amount of gain.

The speech amplifiers originally were Western Electric H.A.'s, made up of three stages of straight A.F., using resistance coupling and operating from batteries. The tubes used are W.E.-239A's which are identical in filament and plate voltage to the WD-12.

These amplifiers were redesigned to use three stages of resistance coupling in push-pull retaining the W.E.-239A's. The schematic is shown in Fig. 3. Direct current must be used on the filaments and to obtain this voltage a copper-oxide rectifier is used on each public address channel. These units furnish 6 volts which is reduced to the operating potential of 1.1 volts by suitable series resistors.

The plate voltage is obtained from the 390-volt maximum potential of the first power amplifier, whose schematic is shown in Fig. 4, and is dropped to about 175 to 200 volts through the biasing and plate resistors.

Now as Western Electric condenser microphones require voltages for an internal amplifier as well as for the "mike" itself, it would be advantageous to take this voltage from the speech amplifier. Therefore, the "mike" amplifier uses W.E.-239A tubes, and all voltages are supplied from the speech amplifier.

The lines running down from the control room to the various public rooms have an impedance of 200 ohms. The "mikes" have an impedance of 50 ohms. In order to match the microphones to the line it is necessary to either use a matching transformer or, if more than one condenser "mike" is to be used, some sort of a mixing control. It is obviously much better practice to combine a group of "mikes" through a mixer than it is to just connect them across a transmission line; first, because one has individual control over each "mike"; and second, because the impedance of both line and "mikes" remains unchanged.

Design Considerations

To design a mixer that will fulfill the above it is necessary to understand just what an ideal mixer should do in order to produce distortionless output. The first thing is constant impedance controls that will keep the impedance of the line constant regardless of the setting of the controls.

Thinking of Making EXTRA Money in spare time?

Servicing Electric Refrigerators Brings Many Easy Dollars

\$5.00 The
Copy

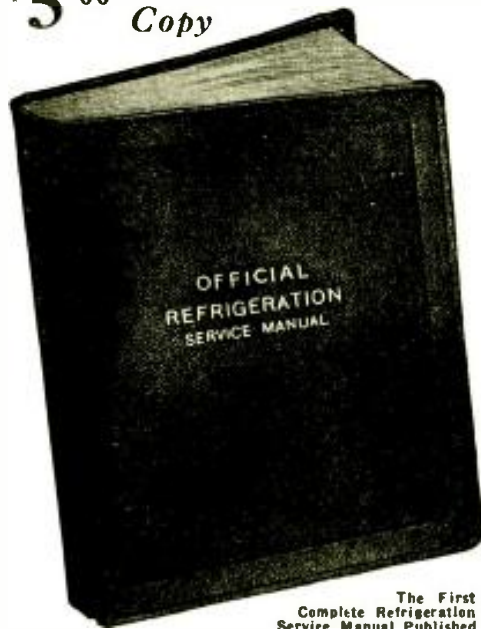

THE idea of electricians, radio service men and other mechanically inclined men, servicing refrigeration units is self-evident and the thought has occurred to perhaps untold thousands ever since electric refrigeration started. Yet nothing was done, because the average man knows little or nothing about refrigeration. Compared with servicing a radio set or wiring a home for electricity, the servicing of a refrigerator is absurdly simple, once you get the hang of it.

The OFFICIAL REFRIGERATION SERVICE MANUAL has been edited by L. K. Wright, who is an expert and a leading refrigeration authority. He is a member of the American Society of Mechanical Engineers, American Society of Refrigeration Engineers, The National Association of Practical Engineers, etc.

In this Refrigeration Manual every page is profusely illustrated; every refrigerator part is carefully explained; diagrams are furnished of every known machine; special care is given to the servicing end. The tools needed are illustrated and explained; there are trouble shooting charts, and other service data.

Remember there is big money in the refrigeration servicing business. There are thousands of firms selling refrigerators every day and they need to be cared for often. Eventually there will be more refrigerators than radios. Why not increase your earnings with a full or spare time business by servicing refrigerators.

OVER 1,000 DIAGRAMS
352 Pages
Flexible Looseleaf Binder
Complete Service Data

Here are some of the important chapters:
Introduction to the Refrigeration Servicing Business
History of Refrigeration
Fundamentals of Refrigeration
Description of All Known Types of Refrigeration
Service Tools and Shop Equipment
Motors
Trouble Shooting
Unit Parts, Valves and Automatic Equipment
Makes and Specification of Units
Manufacturers of Cabinets
Refrigerants and Automatic Equipment
and Many other Important Chapters.

Already hundreds of copies of the OFFICIAL REFRIGERATION SERVICE MANUAL have been sold; and there still remains the greatest opportunity for thousands more to learn how to make more money in a short time through openings in this new field.

Mail Coupon Today!

GERNSBACK PUBLICATIONS, Inc. RC-12
96-98 Park Place, New York, N. Y.

I enclose herewith my remittance for \$5.00 (check or money order preferred) for which you are to send to me, postage prepaid, one copy of the OFFICIAL REFRIGERATION SERVICE MANUAL.

Name

Address

City State.....

SERVICE FORUM

Killing Service Calls

(Continued from page 345)

be taped to stop corrosion at this point. The wire is then dropped to the window.

If a "nail-it" knob can be used here, use it to take the weight of the lead wire off the antenna. At the window, the lead wire should be fastened with one of these knobs to prevent swaying; and should be skinned for about three inches and pushed through the clip of the lead-in strip, leaving about two inches sticking through. This end should be wound once around the head of a tack, and the tack driven home through the small eyelet in the end, to prevent loosening at this point. A tack here will prevent one of the most prevalent complaints I know of.

Of course the above description of an installation is not ideal by any means; but it is about the best that can be done in a city apartment with the time allowed an

installer. I have not forgotten the lightning arrester; about the best place for this is fastened to the inside of the cabinet, with two separate leads running from the binding posts on the chassis to the arrester. These wires can then be easily disconnected.

The operation of the set should then be explained to the customer, with a short talk on the various noises that will be encountered.

The average time for the above installation, checking tubes, etc., is about one hour and, counting traveling time on a straight route, about seven can be done in an eight-hour day.

(Simple as these recommendations appear, they are worth while to consider.—*Service Editor.*)

Condenser-Rectifier

(Continued from page 344)

As the voltage applied to the condenser decreases, the first half of the condenser begins to discharge thus maintaining the current constant. In other words, while one-half of the condenser is charging, the other half is passing current, and as this current decreases, the first condenser begins to discharge thus keeping a constant current through the load.

It can be seen that the rated voltage of the condenser should be equal to the peak value of one-half of the total transformer voltage. For rectifying and filtering high voltages and currents a series-parallel combi-

nation of electrolytic condensers may be used to advantage.

Referring to the diagram, when the metal plate of one-half of the condenser becomes positive the electrolyte is negative. No current can flow through this half of the condenser, but a short heavy charging current flows that raises its potential until it is equal to the peak value of the A.C. voltage across the transformer. Thus this half of the condenser becomes charged at the same time the second half of the unit is passing current to the load because the electrolyte is positive with respect to its metal plate.

In the past many engineers thought that an ordinary potentiometer would perform satisfactorily, but experience and theory have definitely proved that the use of a potentiometer results in very poor frequency response when the potentiometer is used across a line as a volume control.

In Fig. A is shown the type of mixer that is used in the New Yorker; the schematic circuit is illustrated in Fig. 5.

Let us now consider the attenuators which are used across the outputs of the "mikes." In Fig. 6A this particular section is shown, and if the circuit is examined it will be noticed that the attenuators are wired in series with the output windings tapped.

Refer now to Fig. 6B. The resistor which is placed across the winding Q changes the effective impedance of the winding. However, if we put another resistor in series with the entire unit as shown, it is possible to once again return to the natural impedance of the winding (that is, to the condition where no shunting resistor is used). The reason being of course, that the series resistor balances out the shunting effect.

This then, is the purpose of the odd tapping arrangement which is used in the finished design, for not only is it possible to keep the impedance constant but also the shunting effect is eliminated for all practical purposes. The values of the various parts

of the attenuators as used in this mixer are given in Fig. 5.

However, it is comparatively simple to design a pad for any audio circuit. These values are computed by using the following formulas:

Z = THE IMPEDANCE AT 1,000 CYCLES

$$R_1 = 3Z$$

$$R_2 = \frac{(Z)(r)}{Z+r}$$

$$R_3 = Z$$

R = THE OUTPUT RESISTANCE OF THE MICROPHONE UNIT.

R, a resistor having the same resistance as the "mike" unit output transformer secondary is inserted in place of the "mike" unit whenever the "mike" unit is thrown out of the circuit, thus keeping the value of R always constant.

The switching arrangement shown in the schematic makes it possible to read all voltages and the plate current of the "mike" amplifier tube (which is built into the condenser mike unit).

The mixer gives excellent results and the output is in no way lacking of either highs or lows. For further information on constant-impedance volume controls the author refers you to the August issue of RADIO-CRAFT wherein this subject was discussed.

AERO WORLD-WIDE

Only **\$645** Short Wave Receiver

Span the World with this Set.



A new radio thrill for you! Listen in DIRECT to London, Paris, Berlin, Buenos Aires and other broadcasting stations throughout the world via short waves. Enjoy unique foreign programs from strange lands. Your ordinary receiver cannot take in these low wave stations. WORLD-WIDE RECEIVER gets 14 to 550 meter stations with surprising clarity.

AERO SHORT WAVE

Super-Heterodyne Converter

Converts Your AC or DC Radio Set Into a Short Wave Super-Heterodyne 15 to 200 METERS



Now in addition to your regular receiver you can have a Short Wave Super-Heterodyne set that will enable you to tune in short wave stations from many different parts of the world. All you have to do is to connect the Aero Converter to your own set and you are then ready to span the world. The Aero Converter is adaptable for AC or DC radio sets. Contains its own filament supply. B voltage can easily be obtained from your regular radio set, or you may use a single 45 voltage B battery. No plug-in coils. Single tuning dial. Very easy to tune. No whistle or squeals. Uses two UX227 tubes, one as oscillator and one as mixer.

Price List

AC Model, less tubes, ready for operation.....	\$12.50
DC Model for battery-operated sets.....	11.50
2 Matched UX227 tubes at 75c each.....	1.50
1 45 Volt B Battery.....	1.45

New Aero Midget \$16.50



Using the latest type Pentode and Multi-Mu Tubes. This Midget performs on distance and has tone qualities like a large expensive set. Wonderful selectivity. Full dynamic speaker, full vision dial, beautiful walnut finish cabinet. A 5-tube set. Price for set of 5 tubes, \$4.50. Available in 25 cycle \$2.50 extra.

Aero Pentode Auto Radio

Amazingly Low Price! Quality Performance



We guarantee this is the latest model 8 tube Aero Pentode Auto Radio. Due to the use of the latest Pentode Tubes, this set is equal in performance to any 8-tube receiving set. The circuit used is one which will be embodied in most of the expensive 1932 model auto radios. The

complete set can be clamped on the steering post of your car or can be operated by remote control from the dashboard. This set will pull in stations within a radius of 1,000 miles and will deliver the volume and tone qualities of an electric set.

Price of Set only \$20.00

Price complete, including tubes, batteries, dynamic speaker and suppressors, all ready to install and use. \$38.50.

TERMS: Should you order C. O. D., a deposit of \$1.00 is required on Short Wave Receiver or Short Wave Converter. A deposit of \$5.00 is required on the Aero Midget or Auto Radio. 3% discount allowed if remittance is sent in full.

Write for Bargain Catalog

CHARLES HOODWIN COMPANY

4240 Lincoln Ave., Dept. M-150 Chicago, Illinois

SKINDERVIKEN



The Most Sensitive Microphone Button
(ACTUAL SIZE NOT BIGGER THAN A QUARTER)

You can easily make a highly sensitive detectophone by using a Skinderviken Transmitter Button to collect the sound waves. You can build your own outfit without buying expensive equipment. Think of the fun you can have with such an instrument.

You can install an outfit in your home and hear the conversation being held all over the house.

Full directions for connecting the button for use as a detectophone are given in our 12-page booklet.

These wonderful little SKINDERVIKEN microphone buttons may be used for hundreds of uses, such as:

- RADIO AMPLIFIER
- DETECTOPHONE
- STETHOSCOPE
- MICROPHONE
- PHONOGRAPH AMPLIFIER
- TELEPHONE AMPLIFIER
- LOUD SPEAKER AMPLIFIER
- CRYSTAL SET AMPLIFIER
- HOME RECORDING OUTFIT, ETC.

95c EACH Two for **\$1.75**
12-PAGE INSTRUCTION BOOKLET
 containing suggestions and diagrams for innumerable uses, furnished with each unit.

EVERY AMATEUR SHOULD HAVE TWO OR THREE OF THESE AMPLIFIERS IN HIS LABORATORY

WE PAY \$5.00 IN CASH
 for every new use developed for this unit and accepted and published by us.

SEND NO MONEY

When the postman delivers your order you pay him for whatever you have ordered, plus a few cents postage.

(Canada and Foreign: cash with orders)

PRESS GUILD, Inc., RC-1231
 16 Murray St., New York, N. Y.

Please mail me at once as many of the following items as I have indicated.
 ...Skinderviken Transmitter Units at 95c. for 1; \$1.75 for 2; \$2.50 for 3; \$3.20 for 4.

When delivered I will pay the postman the cost of the items specified plus postage.

Name

Address

City..... State.....

RADIO AGENTS WANTED

Short Wave Units—RADIOPHONE

Earn up to \$100 a week. Every Radio Fan Interested. Latest WOAKRITE Models. Operates on any radio. Thrill to all. Special Home Demonstrator offer to LIVE WIRES. So write today to 20th Century Co., 1569 Coke Bldg., Kansas City, Mo.

PATENTS Write for Free Guide Book, "HOW TO OBTAIN A PATENT" and Record of Invention Blank. Send model or sketch and description of your invention for our Free Opinion whether it comes within Patent Office Rules. RADIO and ELECTRICAL Cases a Specialty. Prompt, Efficient Service. PAYMENT OF FEES IN INSTALLMENTS VICTOR J. EVANS & CO., 923 - 9th, Washington, D. C.

FAVORITE TEST EQUIPMENT

An Improved Ohmmeter

(Continued from page 349)

and even this is not absolutely essential. The following is a suggestion for the construction of an instrument of this type adapted to read lower values than usual.

Most constructors advocate the shunting of the 0-1 milliammeter to 10 ma. in order to read the lower values of R, but it is simpler and better to use lower values of E; for instance if E is in millivolts and I in milliamperes then R will be given directly in ohms, where R is the sum of the unknown resistance and the resistance of the milliammeter. Fortunately, millivoltmeters are one of our most common types of instruments though everyone may not recognize it; for example, all Weston 301 milliammeters above 30 ma. are calibrated to 100 millivolts, and provided with a shunt such that the drop is 100 mv. when the full scale current is flowing. For our purpose a 0-100 milliammeter with the shunt removed gives us a 0-100 millivoltmeter, scale and all; if this is provided with multipliers for 1 and 10 volt ranges it will be just what we need. Thus in Fig. 4 we have an instrument reading from 0 to 100,000 ohms which can be made quite compact. The list of parts for this tester is as follows: the battery may be four of the small penlight batteries to furnish 12 volts; a 0-2000 and a 0-200 ohm potentiometer to vary the voltage; a Weston 301, 0-100 milliammeter with the shunt removed and provided with 1 and 10 volt multipliers; a three point switch for the voltmeter ranges, a Weston 301, 0-1 milliammeter, a push button switch for the battery circuit (thus avoiding undue drain on the battery); and a panel and case as desired by the individual builder. These should be wired with fairly heavy wire, old fashioned No. 14 bus makes a neat job.

The ranges covered are as given in the following chart:

Ma. Reading	Vm. Range	Range in Ohms (Weston 301)
1.0	0-100 mv.	0-73
1.0	0-1000 mv.	50-973
1.0	0-10 volts	500-10,000
0.1	0-10 volts	10,000-100,000

To calibrate the multipliers for the 1 and 10 volt ranges it is easiest to use a 0-10 voltmeter as a standard; the approximate values will be 40 and 400 ohms.

To determine the correction to be made for the resistance of the milliammeter, short the terminals at R and read resistance, subtract this from the total to obtain the true value when measuring an unknown resistor; if a Weston 301, 0-1 milliammeter is used, the value to be subtracted will be 27 ohms. For the higher values of resistance it will not be necessary to make any correction.

SILVER ANNIVERSARY BOOKLET
A HISTORY of the "Audion" is available to anyone sending a stamped addressed envelope to the DeForest Radio Co., Passaic, N. J., for a copy of "A Quarter Century of Radio Progress." This attractive and instructive booklet was prepared as a souvenir of the Silver Anniversary (1906-1931) of the De Forest "Audion."

STATEMENT OF THE OWNERSHIP, MANAGEMENT, CIRCULATION, ETC., REQUIRED BY THE ACT OF CONGRESS OF AUGUST 24, 1912.

Of Radio-Craft, published monthly at Mt. Morris, Ill., for October 1, 1931.
 State of New York
 County of New York

ss. Before me, a Notary Public in and for the State and county aforesaid, personally appeared Irving S. Manheimer, who, having been duly sworn according to law, deposes and says that he is the business manager of Radio-Craft and that the following is, to the best of his knowledge and belief, a true statement of the ownership, management, etc., of the aforesaid publication for the date shown in the above caption, required by the Act of August 24, 1912, embodied in section 111, Postal Laws and Regulations, to-wit:

1. That the names and addresses of the publisher, editor, managing editor, and business manager are: Publisher, Techni-Craft Publishing Corp., 401 North Wesley Ave., Mt. Morris, Ill. Editor, Hugo Gernsback, 98 Park Place, New York City. Managing Editor, R. D. Washburne, 98 Park Place, New York City. Business Manager, Irving S. Manheimer, 98 Park Place, New York City.

2. That the owners are: Techni-Craft Publishing Corp., 404 No. Wesley Avenue, Mt. Morris, Ill. Hugo Gernsback, 98 Park Place, New York City. Sidney Gernsback, 98 Park Place, New York City. D. Manheimer, 98 Park Place, New York City.

3. That the known bondholders, mortgagees, and other security holders owning or holding 1 per cent or more of total amount of bonds, mortgages, or other securities are: None.

4. That the two paragraphs next above, giving the names of the owners, stockholders, and security holders, if any, contain not only the list of stockholders and security holders as they appear upon the books of the company but also, in cases where the stockholder or security holder appears upon the books of the company as trustee or in any other fiduciary relation, the name of the person or corporation for whom such trustee is acting, is given; also that the said two paragraphs contain statements embracing affiant's full knowledge and belief as to the circumstances and conditions under which stockholders and security holders who do not appear upon the books of the company as trustees, hold stock and securities in a capacity other than that of a bona fide owner; and this affiant has no reason to believe that any other person, association, or corporation has any interest direct or indirect in the said stock, bonds, or other securities than as so stated by him.

IRVING S. MANHEIMER
 Sworn to and subscribed before me this 24th day of September, 1931.

MAURICE COYNE, Notary Public.
 (SEAL)
 (My commission expires March 30, 1932.)

Classified Advertisements

Advertisements in this section are inserted at the cost of ten cents per word for each insertion—name, initial and address each count as one word. Cash should accompany all classified advertisements unless placed by a recognized advertising agency. No less than ten words are accepted. Advertising for the January, 1932, issue should be received not later than November 9th.

FORMULAS

MAKE AND SELL your own products. We will furnish you any formulas. Write for our literature. Chemical Institute, 19R Park Place, New York, N. Y.

RADIO

SERVICE MEN, ATTENTION—Speakers re-wound, magnetized, repaired, \$2.00 to \$2.75. Complete Power Pack Service—Transformers re-wound, condenser blocks repaired, resistors duplicated. Guaranteed. Clark Brothers Radio Co., Albia, Iowa.

MAKE World's simplest radio. Crystal with instructions, 25c. Music Sales, Independence, Mo.



\$5,000 WILL BE PAID TO ANYONE WHO PROVES THAT THIS IS NOT THE ACTUAL PHOTO OF MYSELF showing my superb physique and how the Ross System has increased my own height to 6 ft. 3 3/4 inches. Hundreds of Testimonials. Clients up to 45 years old gain from 1 to 6 inches in a few weeks!!

First in 1907 First To-day

No Appliances—No Drugs—No Dieting. ROSS SYSTEM NEVER FAILS. Fee Ten Dollars Complete. Convincing Testimony and Particulars 5 cents stamp. Allow time for return mails across the Atlantic." G. MALCOLM ROSS, Height Specialist, Scarborough, England. (P. O. Box 15).



OPERATING NOTES

(Continued from page 351)

condensers open circuit, causing one '45 tube to become inoperative. When one of the leaks opens, repair is easily effected, for these carbon resistors are readily accessible.

A defective coupling condenser either shorted or open-circuited presents quite another problem, for these units are incorporated in the so-called (RCA) capacitor and coupling reactor pack. It stands without question, that the complete reactor pack can be changed, but this is unnecessary, though many of these units, most likely, have already been replaced. The only changes necessary are the addition of the new .025-mf. condenser to the grid circuit of the '45 stage containing the shorted condenser.

Two green wires emerge from the capacitor reactor block that go to the grids of the '45 tubes, as shown in Fig. 2. Place the new unit in series with the lead which comes from the defective unit (shorted) and that job is done. However, when either of the two coupling condensers open-circuits, the change is slightly more complicated. Here we must determine which of the two in the pack or block is open. This can be done by the discharge method, testing from one grid of the '45 to terminal No. 5 on the block, or the lump of solder located in one corner of the block between terminals Nos. 3 and 4. The new unit should be connected in series between No. 5 and the grid of one '45, or in series with the lump of solder to the grid of the other '45.

Distortion on Radiolas "80," "82" and "86" will be found in some cases to be caused by an open 60,000 ohm carbon resistance in series with the push-pull input secondary return. Almost all resistors used in Radiola and Victor sets use Wood's metal ends. When the proper value for a repair is not at hand, a temporary and usually a permanent job can be had by sweating the Wood's metal ends with the tip of a hot electric soldering iron. However, care should be exercised in applying the iron, for Wood's metal has a very low fusing point. The "open" usually occurs at the end of the resistor and sweating often does the trick of repair.

The same trouble found on several Peerless Couriers caused much aggravation to several Service Men. The receiver burned out the '80 rectifier as soon the set was turned on. A dead short was found across the filter output. Each condenser was disconnected and given a charge-discharge test and each checked perfectly. After several hours of work, it was found that the condenser with the yellow lead emerging from the condenser block broke down under load. This same condenser was found to act the same way on several receivers.

For at least six months, Service Men were perplexed by the problem of fading in the Kennedy "632," in which volume would cut down to an audible whisper and, after a few moments, come back to normal before a test could be made to determine the cause. Several of these chassis were taken into the shop to undergo a "life test," and as soon as a set became inoperative, tests were made.

For instance, in one case, the detector plate voltage was found almost nil, accompanied by an increase in other voltages. This was traced to a partial short in the detector's plate filter, (a combination which consisted of an R.F. choke and condenser assembly, similar to that used in the Stromberg-Carlson "641," "642," "652") one condenser being the apparent cause of the trouble; pressure on the sides of the case would clear the short, or bring it back. Instead of discarding the unit, the metal case of which was grounded, it was carefully taped and insulated, and external .002-mf. condensers were connected from either side of the choke to chassis.

In another case, the .06-mf. blocking condenser was found to open and close the circuit, causing fading; the remedy in this case was replacement. If a tone lower in pitch is more pleasing to the owner, a 0.1-mf. condenser may be substituted for the .06-mf.

This model incorporates a certain type of Jensen speaker, in which the voice coil is wound with a wire resembling aluminum; the flexible pigtails cannot be soldered, so the connection is obtained through a heavily-compressed mechanical contact. Vibration, loosening the contact, produces an open coil and fading, then sudden recovery. When the fact, that all voltages were correct and receiver parts in good order, pointed to a faulty speaker, this was replaced with another Jensen instrument of nearly the same characteristics.

SERVICING MAJESTICS

(Continued from page 351)

There is a simple method to test the filter pack condensers in the three different types of Majestic powerpacks. Each type can be identified by the number of connections or taps on it. The 9P6 has ten, the 8P6 has eleven, and both the 7P6 and 7BP6 have twelve. We are only interested in connections 1, 2, 3 and 4, Fig. A.

Disconnect the powerpack from the set and then turn it on so that the G-80 tube lights up. If there is a frying and popping in the condensers it shows that one was leaking and that the no-load voltage of the pack has broken it down. If the frying does not occur, then with a screwdriver short from No. 1 to No. 4. This should give a white breakdown flash. If it gives a red arc, it means that one or more condensers are open. After leaving it on for a minute or two, turn it off, and about fifteen seconds later test again from No. 1 to No. 4. There should be a white breakdown discharge. If not, it indicates that one of the condensers is shorted or leaking.

In the Majestic "90" series, trouble has been experienced with the .004 detector plate by-pass condenser. In nearly every case where they have broken down it will be noticed that two .002 condensers of like manufacture have been riveted together. In replacing, be sure to use two riveted together of different makes. It seems that they stand up better if that precaution is taken.

the building and repairing of all kinds of radio receivers!



THE three volumes of this Library cover the entire field of building, repairing and "trouble-shooting" on modern radio receivers. The Library is up-to-the-minute in every respect and is based on the very latest developments in the design and manufacture of equipment. The rapidly-growing interest in short-wave and television reception is thoroughly covered in a complete section which deals with the construction of this type of apparatus.

Radio Construction Library

INCLUDING CONSTRUCTION OF SHORT-WAVE AND TELEVISION RECEIVERS

By JAMES A. MOYER and JOHN F. WOSTREL

Faculty, University Extension, Massachusetts Department of Education

Three Volumes — 1087 Pages, 6x9
605 Illustrations

VOLUME I: presents the fundamental principles of radio so clearly and simply that anyone of average training will be able to read, understand and apply them. It gives actual working drawings and lists of materials for the construction of many typical sets.

VOLUME II: fully discusses all of the elementary principles of radio construction and repair. An explanation of the necessary steps for "trouble-shooting," repairing, servicing and constructing radio sets successfully. Practical data is also given on antenna systems, battery eliminators, loud speakers, chargers, etc. This volume includes complete instructions for the construction and operation of short-wave and television receivers.

VOLUME III: covers the essential principles underlying the operation of vacuum tubes in as non-technical a manner as is consistent with accuracy. It discusses the construction, action, reactivation, testing and use of vacuum tubes; and an interesting section is devoted to remote control of industrial processes; and precision measurements.

EXAMINE these books for 10 days FREE

This Library is not only a thorough home-study course, but a handy means of reference for the more experienced radio experimenter, repair man, and radio shop-owner. To these men, as well as to those who desire to advance in the radio profession, this offer of a 10 days' Free Examination is made.

Simply clip, fill in, and mail this coupon

McGraw-Hill

FREE EXAMINATION COUPON

McGraw-Hill Book Company, Inc.,
370 Seventh Avenue, New York.

Gentlemen:—Send me the new RADIO CONSTRUCTION LIBRARY, all charges prepaid, for 10 days' Free Examination. If satisfactory I will send \$1.50 in 10 days, and \$2.00 a month until \$7.50 has been paid. If not wanted I will return the set at your expense.

Name

Home Address

City and State

Position

Name of Company..... RC-12-31

(WRITE PLAINLY AND FILL IN ALL LINES)

Build Your CUSTOMERS THE Revolutionary STENODE

The Receiver That Is NOISE FREE on SHORT WAVES or BROADCAST



STENODE selectivity curve makes 10KC selectivity, so-called, look like broad tuning.

STENODE selectivity is compared, at left, to that of ordinary receivers. All background noise is contained in outer curve. Stenode's curve, shaded, contains but 1-10 the total noise.



STENOTUBE. Only one required in each Stenode. This heart of the Stenode circuit consists of a quartz crystal ground to 175KC frequency and mounted in tube form for easy handling. Standard UX socket base. Price \$15.

Made in England

None genuine without the inventor's signature.

James Robinson

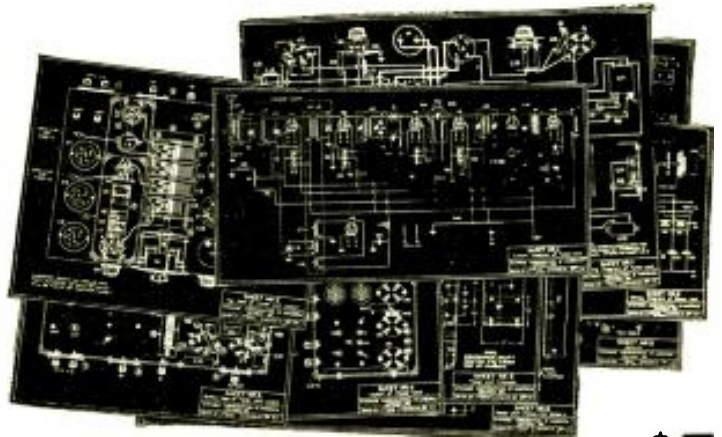

A STENODE demonstration will create more new custom set prospects than any radio receiver ever did before. People listen in amazement when they hear stations free of background noises and absolute silence between stations. When you tune out heterodynes and whistles and stations STAY IN strong and crystal clear, owners of all other sets gasp in astonishment. The former chief of wireless research of the British Royal Air Force, Dr. James Robinson has given an entirely new principal to radio in STENODE.

By the STENODE principal the highest selectivity ever attained as well as unprecedented tonal range is now made possible. All engineers agree that it is impossible with ordinary super-heterodynes.

STENODE amplifies signals most and static least. That's why YOU want to build an 11 tube STENODE to work with a SHORT WAVE adapter when it is not used to log and listen with enjoyment to more broadcasters than can be heard on any other type of radio. STENODE selectivity is 5 to 1 greater than that of so called 10KC Supers. The noise does not get in along with the high audio frequencies, and the STENODE reproduces perfectly higher frequencies than ever heard on any other receiver giving

500% BETTER SELECTIVITY
1000% MORE FREEDOM FROM NOISE
INFINITELY BETTER QUALITY

9 Blue Prints - Data Book - Direction Book Now \$5

Increased demand for Stenode Data Book, Instruction Book and Blue Prints permits our cutting former price in half. Those who have already sent in full price will receive our check for \$5. We are not interested in making profit from our engineering service. Our profits come solely from Royalties paid us by our licensees.

GERNSBACK PUBLICATIONS, Inc.
98 Park Place, New York, N. Y.

Enclosed find Money Order, Check, for \$..... Please forward me STENOTUBE, BLUE PRINTS, DATA BOOK and DIRECTION BOOK for building STENODE.

(Note: all checks payable to Gernsback Publications, Inc.)
Name

Street

City State

The STENODE opens up new fields for short-wave and television work, as well as broadcasting. Full details of all sorts of applications are given in the STENODE Data Book. Nine full-sized diagrams show where to place every part. How to make every connection is clearly told in STENODE Book of Directions. Your finished STENODE will put you into a new field of radio. Fill in and mail the coupon with your money order for the biggest value ever offered custom set builders.

STENODE CORP. OF AMERICA
GERNSBACK PUBLICATIONS, Inc.
98 Park Place New York, N. Y.
SOLE SELLING AGENTS

IF IT ISN'T A STENODE IT ISN'T A MODERN RECEIVER

RECORDING STUDIOS

(Continued from page 352)

out, it will be observed that no sound originating in the studio will be heard outside, and vice versa, no sound originating on the outside will be heard inside the studio. As an added insurance against external noises, the outside of the outer wall is covered with an insulating material such as Celotex. The inside walls and ceiling should be partly covered with heavy drapes so as to lower the reverberation constant. The amount of drapery is best determined by experiment. The room should have a slight amount of resonance so that the faithful recording of the high notes is possible. By a slight amount of resonance is meant that the conditions must be such that a person talking at the microphone will sound the same as a person talking in an average dining room. It must be borne in mind that in commercial work the proper acoustical treatment of the recording room is just as important an item as the apparatus itself, and no effort should be spared to achieve these results. Good records mean "repeat business."

Studios for Orchestras and Bands

Studios that are to be used for orchestral recording are naturally more elaborately equipped than studios intended for vocal work only. In the first place, two or more rooms are required and more than one attendant is necessary. As is seen in Fig. 2, the recording room is adjacent to the studio and is separated from the latter by means of the double wall which is insulated against the transmission of sound from one room to the next. The advantages to be obtained in locating the two rooms adjacent to each other are two; first, the input leads from the microphone are kept as short as possible, thus minimizing the picking up of extraneous noises, and second, the man at the mixer has a full view of the studio so that at times he may anticipate the action in the studio which in itself is a tremendous aid in obtaining a good recording.

Fig. 3 shows a block schematic of the apparatus to be used. It is recommended that at least two, if not three, microphones be used so that proper pick-up of the different pieces of an orchestra may be accomplished.

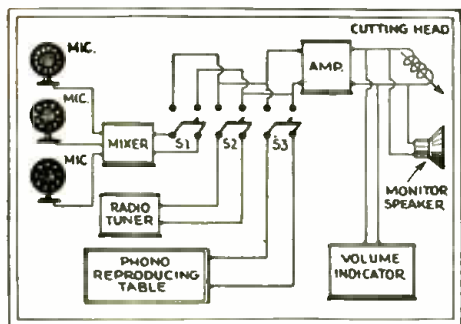

Fig. 3

The switching arrangement for connecting either alone, or in any combination the microphones, radio or phonograph to the recording amplifier.

Mixers

One of the most important parts in the recording system is the mixer panel. This is used for mixing various incoming signals, and regulating the volume and combining them before being fed to the amplifier. Figs. 4, 5, and 6 show three different types of present day mixers. The one shown in Fig. 4 is known as a series potential divider type mixer. The main disadvantage of this type is the variation of impedance with each individual manipulation of the mixer gain control.

The parallel constant output impedance type shown in Fig. 5 is one that has been used quite extensively in the past for speech

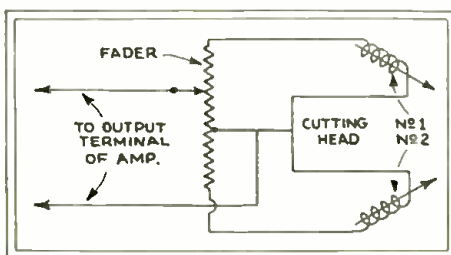

Fig. 7

Fading either one of two cutting heads for continuous recording.

work. However, this mixer introduces considerable distortion due to the fact that there is a variation from 200 ohms to zero of the input impedance.

In Fig. 6, the series type constant output impedance mixer is shown. This type is used extensively where high quality recording is desired. This system is much more preferable to the one shown in Fig. 5 because the output impedance of the bank can be closely matched to the input impedance of the amplifier.

Mixer Technique

Under ordinary conditions the mixer dials should be set at the beginning of a record and not touched thereafter. Of course there are exceptions to this rule; for example, when the mixer man sees that his level indicator is jumping past his danger mark on some particular notes, he is justified in cutting down his volume and then raising it when the danger is past.

Some operators are not very careful in the placing of the microphones for best pick-up, and as a result of this they have to resort to twisting the mixer dials to obtain the best results. This procedure is not recommended. The less manipulation of the controls during the recording the better chance there will be for a good record.

The most common fault to be found among mixer men is their marked tendency to try and do the work of the orchestra leader. Some have their own particular ideas on how much high or low frequencies there should be recorded and as a result the record is usually an interpretation of the mixer man's idea of the piece rather than that of the leader, much to the chagrin of the latter. Some maestros now have the level in-

Short-Wave Superheterodyne Converter

NEW IN DESIGN
15 to 200 METERS

WORLD WIDE RECEPTION
UNLIMITED RANGE



Model 440—4 tubes \$34.50
Model 400—3 tubes \$29.50

The R.S.L. Superhet short wave converter operates with any make of radio. It merely connects to the antenna post of your receiver. Has self-contained power pack, no other connection, can be left connected permanently, has change-over switch for either short wave or broadcast reception. Model 400 three-tube for extremely sensitive receivers. Model 440 four-tube with R.F. stage, for any type receiver.

Send prepaid if check accompanies order; or C. O. D. with one dollar deposit.

RADIO SERVICE LABORATORIES
442 So. Dearborn St., Chicago, Ill.

SERVICE MEN Send for this Book

FREE!



YOU NEED IT!
Everything for your business from the finest mike to the smallest screw is in this book.

GUARANTEED QUALITY GOODS
PRICES LOWEST EVER QUOTED
Fresh new dependable Merchandise at Bargain Prices!
Leading Manufacturers Lines Complete
Send For Your Copy Now!
HEADQUARTERS
for SERVICE MEN'S SUPPLIES

RADOLEK CO.
601 W. Randolph St.
CHICAGO
Illinois

USE THIS CONVENIENT COUPON
Radolek Co.,
607 West
Randolph St.
Chicago, Ill.

Please send me without obligation your Service Man's Supply Book.

Name _____
Address _____
City _____ State _____

Learn Chemistry

Dr. Sloane Will Teach You in Your Own Home

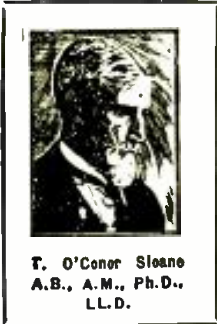

Chemistry offers those who are ambitious and willing to apply themselves conscientiously, the greatest opportunities of any vocation today. Industrial firms of all kinds pay tempting salaries to get the right men. Opportunities abound on every hand.

Now Is the Time to Study Chemistry

Never before has the world seen such splendid opportunities for chemists as exist today. In factories, mills, laboratories, radio and electrical shops, industrial plants of all kinds, chemistry plays a vital part in the continuation and expansion of the business. No profession offers such opportunities and the next ten years are going to show the greatest development in this science that this country has even seen.

You Can Learn at Home

Our home study course, written by Dr. Sloane himself, is practical, logical and remarkably simple. It is illustrated by so many experiments that are performed right from the start that anyone, no matter how little education he may have, can thoroughly understand every lesson. Dr. Sloane will, in addition, give you any individual help you may need in your studies.

Easy Monthly Payments

You do not have to have even the whole price of the course to start. You can pay in small monthly amounts, earning the cost as you go along. The tuition is very low, and includes your laboratory outfit—there are no extras to buy with our course.

Experimental Equipment Given to Every Student

We give to every student without additional charge his chemical equipment, including fifty pieces of laboratory apparatus and supplies and forty-two different chemicals and re-agents.

Tuition Price Reduced

Besides furnishing the student with his Experimental Equipment, we have been able, through the big increase in our student body, to reduce the cost of the course. Write today for full information and free book, "Opportunities for Chemists."

Mail the Coupon NOW!

CHEMICAL INSTITUTE OF NEW YORK, Inc.

HOME EXTENSION DIVISION
19 Park Place New York, N. Y.

CHEMICAL INSTITUTE OF NEW YORK,
Home Extension Division
19 Park Place, New York, N. Y.

Please send me at once, without any obligation on my part, your free Book "Opportunities for Chemists," and full particulars about the Experimental Equipment given to every student. Also please tell me about your plan of payment.

NAME
ADDRESS
CITY STATE.....
R-C1231

MICROPHONE CATALOG

DESCRIPTIONS of the latest microphones, transformers, etc., frequency graphs, and correct operating circuits, appear in the new 1932 catalog of the Universal Microphone Co., Ltd. (copies of which are available by writing to Allied Engineering Institute, Suite 541, 98 Park Place, New York City).

A SHORT WAVE CONVERTER



The short wave converter that has its own power supply, making operation independent of the type of receiver used.

A SHORT wave converter that operates on the superheterodyne principle whose operation is independent of the type of receiver used is illustrated in the accompanying photograph. The simplicity of such a design is obvious when it is realized that the only connection to the regular receiver is the antenna post.

This "midget" converter is made in two models; the "400" converter 4 tubes and the "400" with 3 tubes. It is a product of the Radio Service Laboratories.

CONDENSER SAFETY FACTOR

A RECENT comment from Dubilier Condenser Corp. is of interest to anyone in the market for fixed condensers.

It is pointed out that, in the absence of any radical innovations in the paper condenser art, the only safe yardstick whereby to measure relative values is that of sheer bulk.

The low prices of small paper condensers of high voltage rating contrast strongly with the prices of bulky units of increased cost; but in comparison to the value, per cubic inch, based on normal and overload life, the small units may prove to be much more expensive.

IMPROVED NEON TUBES

METALS working in gases, such as neon, tend to throw off minute particles of themselves which blend with the gases. In television neon tubes, this metal is the plate.

The result is increased darkening of the glass; and dimmer pictures as the tube impedance increases. The solution is the use of metals having a low "sputter" factor, such as aluminum (which, however, is too soft), tungsten or tantalum (which are too expensive); these have practically no sputtering characteristic. Iron, with a factor of five, is the best metal to use, and permits the production of long-life, inexpensive tubes having steady brilliancy. Incidentally, copper, gold, silver, lead, and other metals, due to their "sputter" factor of 75 to 100 times that of the metals previously mentioned, are quite unsuited to this service.



GREATEST MAGAZINE IN SHORT WAVES



On All Large Newsstands

4-Color Cover 9"x12" in Size Over 200 Illustrations

RAPIDLY increasing each day are the number of experiments in the Short Wave field—developments which are bringing to this branch of radio thousands of new "thrill seekers." Experimenters, as in the early days of Radio, again have the opportunity to bring about stirring new inventions. Read in SHORT WAVE CRAFT, the *Experimenter's Magazine*, how you can build your own Short Wave Sets, both transmitters and receivers. SHORT WAVE CRAFT is exclusively a short wave magazine—the kind you have wished for so long.

Interesting Articles in the Current Issue

- How to Build a Simple Cheap Short Wave Receiver
- Ore Locating by Short Waves
- Short Wave Landing Beam for Airplanes
- Economical Modulators for Amateur Phone Transmitters
- Latest Short Wave Converters, Illustrated with Photos and Diagrams
- Latest Ultra Short Wave Data
- Direct Reading Inductance Charts
- The Latest Combination Short and Long Wave Super-Het. Photos and Hook-up Diagram

SPECIAL OFFER COUPON

SHORT WAVE CRAFT RC-12
98 Park Place, New York, N. Y.

I enclose herewith my remittance of \$1.25, (Canada and foreign \$1.50) check or money order preferred, for which you are to enter my subscription to SHORT WAVE CRAFT for One Year, also send me the last two issues gratis. I understand that the regular subscription rate is \$1.50 and this offer will be void after November 30. SHORT WAVE CRAFT is published every other month.

NAME
ADDRESS
CITY..... STATE.....

The A. C. D. C. Portable

FOUR-TUBE RADIO RECEIVER

(Continued from page 353)

Other features of this set include the use of "Conoid" shielded R.F. coils, metallized resistors and the new "Infant" model dynamic reproducer. All parts have been selected first, because of their high quality, accuracy, and efficiency; second, because of unusual compactness; and third, because of inherent ability to withstand the rough usage accorded a portable receiver. The metal chassis is extremely compact, being only 10 x 7 1/2 x 1 1/2 ins. high, as shown in Fig. 2.

A sheet iron chassis is used of No. 16 gauge. Only two sides are bent down (front and back) to form the chassis walls. Although the chassis deck is 10 in. long, the upright walls measure only 9 in., since 1/2 in. is cut away at each end. This provides a flange of 1/2-in. width for fastening the chassis to the upright wooden supports in the carrying case.

Next, the holes for the six sockets are to be drilled in the chassis, and the sockets mounted; then, the three binding posts are mounted; also, the terminal plug 42, which consists of a piece of bakelite or composition, 3 1/2 x 1 1/4 x 1/4-in. thick, with pin jacks arranged in two rows. The A.C. and D.C. caps are provided with tips which plug into the terminal jacks. An additional polarizing tip is provided on each cap, to prevent it from being inserted incorrectly.

The three-gang condenser is fastened to the chassis by means of right-angle brackets; the resistor 33 and choke 39 are mounted in back. The chassis is turned upside down and switch 41, resistor 35 and volume control 12 are mounted. The electrolytic condenser is mounted, by means of the mounting ring provided with it. All the other fixed condensers and then the power transformer 31, are mounted as indicated.

The filament circuit now may be wired in. Starting from the 110 volt plug, one side is connected to amperite socket 40 and the

other side to power switch 41. The other terminal of the amperite socket goes to pin jack "c" on the terminal plug, while the other side of the power switch is connected to jack "d." From "c," connection is made to pilot light 34; thence to resistor 33 and then to the filament terminal of socket 9. The filament wiring continues from one socket to the next, so that all four tubes will have their filaments in series. The wiring then returns from the last socket to jack "d."

Grid circuits are wired in next. Flexible leads are brought from the condenser stators of 6, 11 and 17 to the caps of tubes 9, 14 and 21, respectively. A flexible lead is also brought up from fixed condenser 24, to the cap of tube 28, through a hole drilled in the chassis deck. Plate circuits are wired in, then cathode circuits, volume control, by-pass condensers to chassis; then power transformer, rectifier tube and filter system. Resistors 20, 23, 25, 8 and 27 are soldered in place during the process of wiring.

The three R.F. coils are mounted after most of the wiring is completed, since they cover up the bottoms of sockets 9, 14 and 21. A suitable bracket is fastened between the two sides of the chassis, as shown in the bottom view, and the three coils 5, 10 and 16 are fastened to this. The dial is then attached to the condenser shaft. It should be noted that binding posts 1, 2 and 3 must all be carefully insulated from the chassis.

After the wiring is completed, the set is to be tested both on A.C. and D.C.; changing the caps according to the type of current employed. The chassis and speaker are then mounted in the carrying-case, as shown in Fig. 3.

This portable may be used with aerial and ground; or ground alone. In the latter case, a wire jumper should be connected between binding posts 1 and 3, as indicated by the dotted lines in Fig. 1.



EVERY RADIO SERVICE MAN should read this book which tells you how to make more money out of radio service. There are secrets which "old timers" have learned through years of experience. You can now have the benefits of these. You don't pay a penny—you don't promise to pay any—for this book will be sent to you without any obligation of any kind with our compliments if you will sign and send in the coupon. It is part of our plan to help independent radio men profit by the experience of others in the industry and make a bigger income.

Brim Full of Facts

This book was written by a man who has probably had more experience than any one else in the industry. It tells you in simple language the principles and practices which made him the outstanding figure in the radio world that he is today. These are a few of the subjects fully covered: Selling the public on radio service. Value of Personality—Newspaper advertising—Business literature—Types of service letters—Electric signs—Making tulips business butlers.

This book is for service men only and will be sent FREE and fully post paid upon receipt of the coupon completely filled in.

RADIO SERVICE MEN'S GUILD
1259 Fullerton Avenue
Chicago, Illinois.

You may send me your book "Making Money Out of Radio Service" absolutely FREE and fully post paid. (Please answer these simple questions):

What radio training have you had?.....
 No. of years in radio?.....
 Do you give radio all your time?.....
 Have you a store?.....
 Do you work for some one else, if so who?.....
 Name
 Address
 City State.....

Radio Dealers! Radio Service Men!

New Low Prices
 Guaranteed Replacement Condenser Blocks and Transformers Net

Atwater-Kent 37 Cond. Block with chokes	\$3.95
Atwater-Kent 37 Power Transformer	2.95
Atwater-Kent 40 Pack Complete	6.50
Zenith ZEN. Stewart-Warner, Mohawk Blocks	3.45
Majestic "B" Eliminator Cond. Block	2.95
Electrolytic Condenser, 2 Anode	2.10
Electrolytic Condenser, 3 Anode	2.75

Hard-to-get parts—We have them
 Send us your repair work for estimate
 Write for our FREE CATALOGUE
Grant Radio Laboratories
 6521 1/2 South Halsted St., Chicago, Ill.

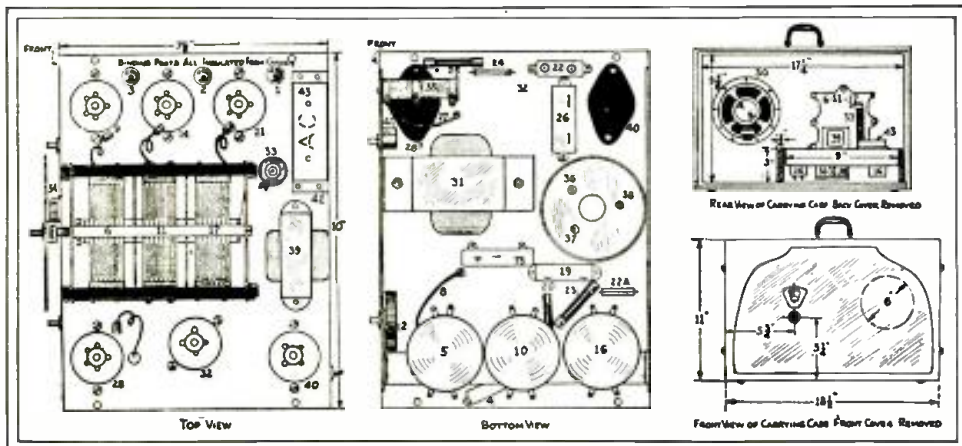
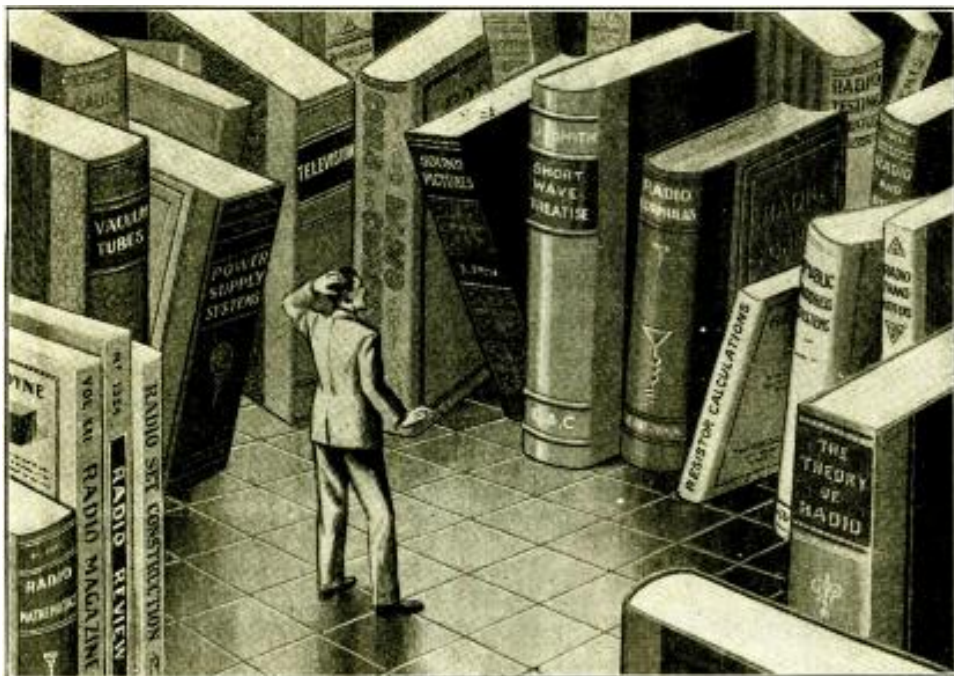

Figure 2, left and center. The complete layout of the parts is indicated. On the left, the top view, in the center, an under-side view. Figure 3, right. The position of the set after it is set in the carrying case. Above, rear; and below, front views.

TUBE CHECKER

Transformers: 1, 1 1/2, 2, 2 1/2, 3, 5, 6.3, 7 1/2 volts, 30 watts. Full instructions included for building new type tube tester. Will test pentodes, 6.3 auto all screen grid and new 2 volt type. Shipping wt. 5 lbs. Add P. P. \$2.25 net.

L & L ELECTRIC CO.
 336 Madison Ave. Memphis, Tenn.



Did This Ever Happen to You?

You want to get the exact and technical meaning of a word or phrase in radio! You are in doubt about a radio formula or radio circuit! You look through a maze of books and magazines losing your time and your temper.

Why not have at your desk or in your library a copy of

**S. GERNSBACK'S
RADIO ENCYCLOPEDIA**

IT gives you an explanation of every word in radio. These explanations—or, rather, definitions—are not brief outline information like those of an ordinary dictionary, but they give in fullest detail, and at considerable length, the meaning and application of every word, phrase, general and special term used in the science of radio. They are written in plain, everyday English, easily understood by anyone.

Practically every definition in the book is illustrated by drawings, photographs, diagrams, or charts. All you need to do is to look up as you would in a dictionary, the word or phrase about which you are seeking information. Furthermore, each page is key-indexed, for greater convenience and speed in locating any definition. ALL THE SUBJECT-MATTER IS ARRANGED IN ALPHABETICAL ORDER.

Numerous tables, charts, and maps are distributed throughout the text. A large section of the Appendix contains information of commercial value, such as lists of all radio receivers, their manufacturers, trade names, tubes used, styles, etc. There are charts of tube-socket lay-outs of all makes of sets; broadcast stations listed by wave-lengths, call letters, towns and states, etc.

In the text you will find biographical notes, with portraits, of all the men who by their inventions, discoveries, and research, have made radio what it is today. Large sections of the text are devoted to such important subjects as television, trouble-shooting, servicing, short-wave reception and transmission, testing instruments, sound projection, etc.

Full descriptions are given of all vacuum-tubes, the theory of their construction, characteristics, testing and manufacturing.

The latest inventions, such as the Radio Knife, Ultra-short waves, Variable-Mu tubes, and locating treasures by radio, are as fully described by word and picture as are the old-time Marconi coherers and detectors.

It took a large staff of editorial assistants and draftsmen over six months to assemble, classify, and illustrate all the material printed in this book.

Mail Coupon TODAY!

S. GERNSBACK CORPORATION RC-12
98 Park Place, New York, N. Y.

Kindly send me one copy of the new Second Edition S. Gernsback Radio Encyclopedia. I enclose herewith \$3.98, check or money order preferred. (Foreign and Canada, add 35c extra for postage.) If the book does not come up to my expectations, or is not as represented, I can return it, and have my money refunded in full.

Name
Address
City..... State.....

The new 1931 Second Edition is a volume of 352 pages. It is a large book 9 inches wide by 12 inches high, and weighs three pounds. There are 2,201 radio definitions, ABC indexed like a dictionary, or any other encyclopedia, making every bit of radio information you want "findable."

The new book contains 1,253 detailed technical illustrations, 34 tables and charts, and 24 pages of Appendix, etc. The binding is flexible red morocco-keratol, with title gold-stamped on cover and back-bone. The text is printed on durable, fine ledger paper, and the loose-leaf construction permits of new material being added, such as notes, addenda data, etc.

Why You Should Own This Invaluable Volume

THIS greatly enlarged Second Edition Radio Encyclopedia is an absolute necessity to everyone interested in Radio. It answers all radio questions, increases your knowledge, and saves your time. It covers every known radio problem, and is a gold-mine of practical information for every radio man.

It is of equal service to:

- The Radio Engineer, who wants to refresh his memory on formulas and circuits;
- The Radio Manufacturer, Jobber, and Dealer, who is interested in the commercial side of radio as well as the technical;
- The Radio Service Man and the Radio Constructor, who wants to have on hand a guide to the principles and design of radio equipment;
- The Radio Student and the Layman, who will find the whole theory and practice of radio explained here in the simplest terms, beginning with the first principles and leading up to the most advanced theory.

THIS book is the NEW 1931 EDITION OF THE FAMOUS FIRST RADIO ENCYCLOPEDIA by S. Gernsback, the first book of its kind ever published in America.

The new Second Edition—just off the press—is fully revised, rewritten, and enlarged. It is the absolutely up-to-the-minute new model of the pioneer First Radio Encyclopedia, which became the stand-by of all radio men in every part of the world.

\$3.98

39,000 Bought the First Edition!

List of Parts

- One .00035-mf. (ea. section) Cardwell Triple Variable Condenser, type 317-C Shielded 6, 11, 17;
- One .1-mf. (ea. section) Double Section Aerovox Metal Case Condenser, type 461-21 7, 15;
- One .1-mf. Aerovox Metal Case By-Pass Condenser, type 260 22;
- One 1/2 mf. Aerovox By-Pass Condenser, type 207 19;
- One 2 mf. Aerovox By-Pass Condenser, type 207 26;
- One Aerovox Triple Section Dry Electrolytic Condenser, type E5-248 in can 2 1/2 x 3 in. dia., 8 mf., 36; 4 mf., 37; 2 mf., 38;
- One .00025-mf. Aerovox mica Condenser, type 1460 4;
- One .001-mf. Aerovox mica Condenser, type 1460 22A;
- One .006-mf. Aerovox Mica Condenser, type 1450 24;
- One Conoid Shielded Antenna Coil 5;
- Two Conoid Shielded R.F. Coils 10, 16;
- One 20,000 ohm Durham Metallized Resistor Powerohm, type M.F.4 20;
- One 200,000 ohm Durham Metallized Resistor Powerohm, type M.F.4 23;
- One 500,000 ohm Durham Metallized Resistor Powerohm, type M.F.4 25;
- One Electrad Volume Control Potentiometer, type RI-202 12;
- One Electrad Truvolt Flexible Resistor, type 2G 1300 27;
- One Electrad Truvolt Flexible Resistor, type 2G 5000 8;
- One Electrad Truvolt Fixed Resistor, type B-70 with tap at 3000 ohms 35;
- One Electrad Truvolt Fixed Resistor, type C-3 33;
- One Amperite Self-Adjusting Line Voltage Control, type 5A-5 40;
- Four Five-Prong UY wafer-type Alden Sockets 9, 14, 21, 28;
- Two Four-Prong UX wafer-type Alden Sockets 32, 40;
- Three Alden Binding Posts 1, 2, 3;
- One Trutest Power Transformer, Secondary 500 volts center-tapped, with 5 volt filament winding for 180 tube 31;
- One Trutest 30-henry choke 39;
- One Trutest Power Switch 41;
- One Special Ansley Terminal Plug 42;
- One Ansley A.C. Cap for Plug 43;
- One Ansley D.C. Cap for Plug 44;
- One No. 15 Gauge Sheet Iron Chassis 10 in. long, by 7 1/2 in. deep, by 1 1/2 in. high, cut from sheet 10 x 10 1/2 in.;
- One Roll Corwico Braidite Hook-up Wire, Solid Core;
- Three 136 Arcturus Screen Grid Tubes 9, 14, 21;
- One 138 Arcturus Pentode Tube 28;
- One 180 Arcturus Full-Wave Rectifier Tube 32;
- One 2 1/2 Volt Dial Light 34;
- One Can Kester Radio Solder (Resin Core);
- One Wright-DeCoster "Infant" model, Dynamic Reproducer 30, equipped with 15,000 ohm impedance output transformer 29 for 138 Pentode Tube;
- One Ansley Leatherette Carrying Case with removable snap-hinge front cover. (For dimensions and other details as to mounting of set, speaker, etc., see accompanying illustrations.)

LATEST in RADIO

(Continued from page 365)

posts of any radio set and serve greatly to increase the selectivity of the receiver as a whole. Of course, if the receiver is of the older, unshielded type, the unit is not likely to function effectively where operation is within local range of a powerful station; naturally, this condition could not be blamed on the Selectifier.

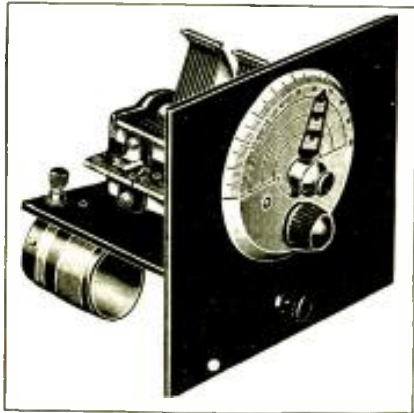

Fig. E

The Band-Selector radio accessory

The tuning condensers are ganged, and shunted by trimmers. Coil L1 has a 15 turn primary and 70 turn secondary; coil L2, vice versa. The tubing is 1 3/4-in. in diameter, wound with No. 28 enam. wire. In addition to the capacitive coupling afforded by C, there is inductive coupling between coils L1 and L2, to maintain even band width over the tuning range.

This device, manufactured by Supertone Products Corp., is recommended to all who desire increased selectivity. Note that the reduction of sensitivity is the same as occurs in all receive combinations incorporating band-selection; and in some circuits it may be found to be compensated by other conditions in the circuit (notably, increased regeneration).

LATE RECEIVER DESIGN

A "DIFFERENT" note in radio receiver design has been struck in the Philco "Lazyboy" illustrated in Fig. F. The top of the cabinet has been lowered to arm-chair level; and the top recessed for tuning and volume controls. Excellent reproduction is obtained from the dynamic reproducer, which is behind the ornamental grille at the end of the cabinet.

As indicated in the schematic circuit of this superheterodyne receiver, which appeared on page 230 of the October 1931 issue

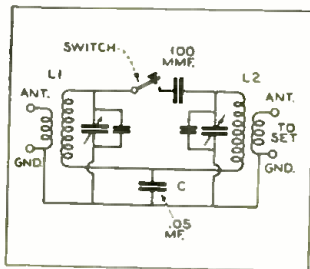

Fig. 6

Circuit of commercial band-selector.

of RADIO-CRAFT, the following tubes are used: four '24's, one '27, one '47 pentode, and an '80 rectifier.

VOLUME CONTROL REPLACEMENT GUIDE

SERVICE MEN are advised to write to Central Radio Laboratories, 900 E. Keefe Ave., Milwaukee, Wis., for their copy of "Centralab Volume Control Guide for Service Men." This twenty-five cent book contains a considerable amount of information of value to the practical radio repairman.

This booklet introduces a new reference method for determining the correct value and type of volume control resistor replacement required for any one of nearly 1,000 different receiver models.

In addition, sufficient engineering information is furnished to enable the Service Men to find out this data concerning models not listed; besides valuable notes in connection with faders, attenuators, tone controls, resistor color codes, ganged units incorporating variable resistors, and other devices. Preferable circuits for each type of service are illustrated.

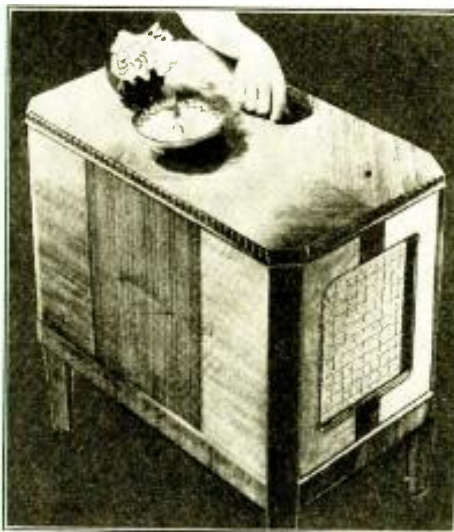

Fig. F

The Philco "Lazyboy." The controls are reached through the top recess; the reproducer grille is on the end.

THE "ALL-TELEVISION" RECEIVER

TO meet the demand for a radio set designed exclusively for operation in the television band, there has been developed a 7-tube receiver incorporating two type '35 variable-mu tubes, three type '27's, one '47, and one '80.

The pentode output tube, after exhaustive tests, was selected as the most satisfactory one to use.

This receiver, manufactured by Television Apparatus Co., contains numerous structural features which will be described in a forthcoming issue of RADIO-CRAFT.

ELECTRICAL ENGINEERING BOOKS SENT FREE

New Edition Containing 100 Pages

A-C RADIO!

8 FLEXIBLE MAROON VOLUMES
4300 pages, 3200 illustrations, deluxe gold stamped binding. Index in each book, general index in Vol. 8. Covers every subject in Electricity—Light, Power, Transmission, Generators, Motors, Switchboards, Radio, Telephone, House Wiring, Railways, etc.

We're glad to send a set to your home to examine and use as your own for 10 days—to show you that here is the most up-to-date and complete work on Electricity ever published. Written by CROCKER of Columbia U.—MILLIKAN of Calif. "Tech."—HARRISON of General Electric and 26 other noted Electrical Engineers. Starts off with elementary Electricity in simple, non-technical language for the beginner and includes every Engineering branch for use of experts on the job.

Complete Electrical Reading Course

Electricity, the biggest industry in the world, continues to grow the most rapidly. And it offers better jobs, bigger salaries and a brighter future than any other field. Every dollar, every hour invested in learning Electricity will come back to you a thousand-fold. Learn in spare time with these books at one-fifth the cost of trade courses. Outline for organized study, quiz-questions and a year's free consulting membership in the American Technical Society included without extra cost. If you mail coupon immediately.

LOOK IT UP!
Thousands of these sets are used as REFERENCE books by men employed in electrical, building construction and allied lines. The JIFFY INDEX puts the answers to 20,000 questions right at your finger tips.

AMERICAN TECHNICAL SOCIETY
Dept. E-926
Drexel Ave. & 58th St., Chicago



AMERICAN TECHNICAL SOCIETY
Dept. E-926 Drexel Ave. & 58th St., Chicago
Please send for 10 days' free trial 8-volume set of Electrical Engineering just off the press, subject to return if I wish to. (I pay the few cents express charges on receipt of books, you pay express if returned.) If I decide to keep them, I will pay \$2.00 after 10 days trial, then \$3.00 a month until \$24.00, special advertising price, is paid, after which books become my property. Year's Consulting Membership to be included free.

Name
Address
Employed by
Employer's Address



THE MASTERPIECE In Microphone Construction —The New Heavy Duty Model "BB"

Model "BB"
List Price
\$25.00
A two-button microphone that has become the talk of the radio industry. It is 3 in. in diameter by 2 in. thick and is nearly twice as heavy as any other microphone in its class. Equipped with extra heavy 21 Kt. Gold Spot centers, Durahm diaphragms, Hairline precision of manufacture. Fully guaranteed. Finished in highly polished chrome plate. Compare this new, heavy duty Model "BB", listing at \$25.00, with any \$10.00 to \$50.00 microphone on the market.

UNIVERSAL MICROPHONE CO., Ltd.
1163 Hyde Park Blvd., Inglewood, Calif., U. S. A.

SAVE SERVICE TIME and MONEY
TRUVOLT RESISTORS, with adjustable clips, mean quicker service and fewer parts to stock. All standard sizes.
Write Dept. RC-12 for Catalog
175 Varick St. New York, N.Y.
ELECTRAD

(Continued from page 373)

● Index to Advertisers ●

A	
Amperite Corporation.....	360
Arco Tube Company.....	379
B	
Blan the Radio Man, Inc.....	366
C	
Cable Radio Tube Corp.....	Inside Front Cover
Carolina Crest Hotel.....	380
Central Radio Laboratories.....	367
Chemical Institute of N. Y.....	378
Chicago Radio Apparatus Co.....	366
Clarostat Mfg. Company.....	370
Classified Section.....	380
Connie's Inn.....	323, 325
Coyne Electrical School.....	363
Crosley Radio Corp.....	363
D	
Drake Hotel.....	380
E	
Electrad, Inc.....	377
Electrical Mfg. Corp.....	364
Victor J. Evans.....	370
G	
Gernsback Corp., S.....	376
Gernsback Publications, Inc.....	326, 368, 372, 374
Grant Radio Laboratories.....	375
Grenpark Company.....	382
H	
Hoodwin Company, Chas.....	369
I	
International Resistance Co.....	359
J	
JMP Mfg. Company.....	360
Johnson Radio Mfg. Co.....	366
L	
L. & L. Electric Company.....	375
Lincoln Hotel.....	380
Lincoln Radio Corp.....	329
Lynch Mfg. Company.....	366
M	
McGraw-Hill Book Company.....	371
Miles Mfg. Company.....	366
N	
National Radio Institute.....	384
Newark Electric Company.....	362
New Bismark Hotel.....	380
P	
Perryman Electric Co., Inc.....	322
Pilot Radio & Tube Corp.....	Back Cover
Polymet Mfg. Company.....	362
Popular Book Corp.....	378
Press Guild, Inc.....	370
R	
Radio & Television Institute.....	357
Radio Circular Company.....	383
Radio College of Canada.....	364
Radio Trading Company.....	381
RCA Institutes, Inc.....	361
Radio Service Labs.....	373
Radio Training Assoc. of America.....	321
Radolek Company.....	373
RCA Institutes, Inc.....	361
Readrite Meter Works.....	358
Ross, Malcolm.....	370
Roth Press.....	379
S	
Scott Radio Laboratories, Inc., E. H.....	327
Silver-Marshall, Inc.....	355
Supreme Instruments Corp.....	327, 328
T	
Tilton Mfg. Company.....	365
Twentieth Century Company.....	370
U	
Universal Microphone Company.....	377

(While every precaution is taken to insure accuracy, we cannot guarantee against the possibility of an occasional change or omission in the preparation of this index.)

director placed in front of them to enable them to control their volume more easily by signaling their hand instead of leaving the interpretation of their piece to the mercy of the mixer man who is usually a better technician than musician.

Double Turntable

The use of a double turntable is absolutely essential in that continuous recordings may be made. The turntables should be provided with a fader so that the cutting in of one recorder while the other is being cut out is accomplished without any loss of sound. This is indicated in Fig. 7. The tables should have a shift mechanism so that they may be run either at 78 R. P. M. or 33 1/3 R. P. M. The large 16" records (33 1/3 R. P. M.) which run from 12 to 15 minutes continuously are especially suited for the recording of radio programs. A full quarter-hour program can be fully recorded on one disc. If the radio recordings are to be made for individual radio stars, then it is inadvisable to give them a 33 1/3 R. P. M. reproducing tables. When the double turn-table is used the fading should be carefully done. Every attempt should be made to make the changeover when there is a hill in the sound, for instance, when a chorus is ended or when a change of action is being noted by music.

Aluminum should not be used for 16" slow speed records because the fibre or thorn needle that is used for playback wears its point out before the record is finished with the natural result of poor reproduction. Only materials that can be played back with steel needles should be used for the large records.

The method of connecting the radio receiver is shown in Fig. 3. It is noted that when switches S1 and S2 are closed, the outputs of both the radio set and the mixer are fed to the cutters. This hook-up allows the studio to make novel records, for example announcements can be made over the regular voice system to introduce any radio program, and talks in the studio may be recorded with a radio musical program.

The phonograph turntable provides the facilities for dubbing, or re-recording as it is more correctly known, and is connected into the circuit by switch S3 (Fig. 3).

The subject of commercial recording is so broad that the writer has not attempted to discuss too much detail due to lack of space, but any information that is desired may be obtained by addressing inquiries to the Sound Recording Department of RADIO-CRAFT.

SOUND-RECORDING EDDIE CANTOR

AFTER Eddie Cantor, comedian, had completed a transcontinental telephone conversation with Samuel Goldwyn, producer, it was stated that the sound-on-film record would become a part of their contract, and would be recognized as legal signatures.

The sound recording equipment, developed by RCA-Photophone, Inc., was connected to the telephone line; and thus it was possible to record both sides of the conversation, in addition to the voices of the telephone operators as they set up their respective connections on the long-distance line.

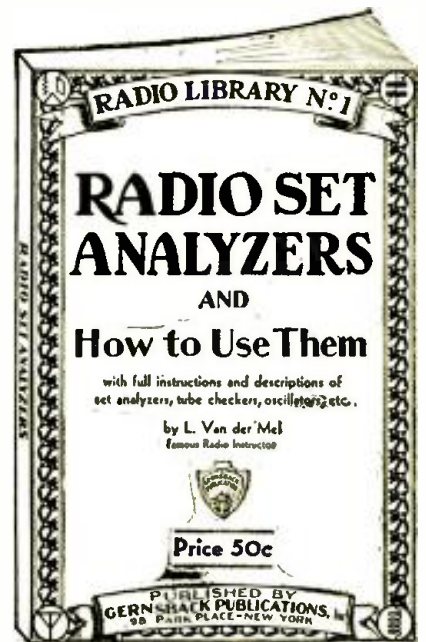

50c The Copy

HERE is the latest book, and one of the most important which we have ever issued. It fills a long-recognized want for there is not a Service Man or a radio-trickian who has not an immediate use for this welcome book.

It is the first book that explains COMPLETELY the operation of analyzers, tube checkers, oscillators, etc., from a thoroughly practical standpoint. The book is intended for Service Men of all classes, whether junior grade or expert. Everyone will find a tremendous amount of live "meat" in its pages. Nothing has been left to your own ingenuity; everything is complete.

- The contents:
- CHAPTER 1: Introduction; The Problems of the Service Man; General Description of Modern Receivers; The Need for a Radio Set Analyzer; What to Expect from an Analyzer
 - CHAPTER 2: The Analyzer; The Fundamental Requirements of an Analyzer; The Switches or Push Buttons; The Ammeter; Multiscale Ammeters; The Shunt and Its Calibration; The D.C. Voltmeter; The Multiscale D.C. Voltmeter; The Multiplier and Its Calibration; The A.C. Voltmeter; The Design of a Simple Analyzer
 - CHAPTER 3: Trouble Shooting with the Analyzer; Classification of Trouble—
 - (1) External to the receiver
 - (2) In the receiver proper
 - (a) Mechanical troubles
 - (b) Electrical troubles.
 Detailed Analysis of Electrical Troubles—
 - (1) Tube Testing
 - (2) Localizing trouble
 - (a) By past experience
 - (b) By actual test of circuit
 - (3) Interpretation of analyzer readings
 - (4) Tube charts (use of)
 - (5) Circuit diagrams (use of)
 - (6) Testing the power unit
 - (7) The use of the analyzer in testing individual units
 Additional Features and Uses of the Analyzer—
 - (1) As a modulated B.F. oscillator
 - (2) As a means of lining up R.F. and I.F. amplifiers
 - (3) As an output meter
 Care and Maintenance of Analyzers; Conclusion and Brief Summary
 - CHAPTER 4: Detailed descriptions, photographs, and circuit diagrams of commercial set analyzers.

This book is sold at a ridiculously low price, because it is our aim to put this valuable work in the hands of 100,000 Service Men and Radio-trickians before the end of this year. Published by RADIO-CRAFT magazine, it has included in it all worth-while information available to the radio servicing profession; and for that reason the price of the book is kept at a very nominal figure.

We know that, if you are at all interested in radio service work, you will send at once for this valuable book.

Rush Coupon TODAY!

GERNSBACK PUBLICATIONS, Inc., RC-12
 96-98 Park Place, New York, N. Y.

I enclose herewith fifty (50c) cents, for which send me a copy of your book "Radio Set Analyzers and How to Use Them."

Name

Address

City and State.....

SHIP RADIO INSTALLATIONS

RADIO technicians may be interested in the following information, furnished by Wright-De Coster, concerning the latest ship's sound installation, which is proceeding rapidly on six mail ships of the United Fruit Line now in construction. The system incorporates central-controlled radio and group address, with sound distribution to six main points.

The rack-and-panel in the control room carries a monitor reproducer of the magnetic type, and a 3-stage power amplifier with type 50 tubes in push-pull. The radio tuner chassis incorporates six stages of R.F. The electric phonograph is provided with an automatic record changer. All dynamic reproducer fields are energized by the ship's current supply, which is 110 volts, D.C. To obtain A.C. for the remainder of the equipment, motor-generators are used.

Dynamic reproducers in ornamental consoles are connected to outlets in the dining saloon, smoking room, and in the ball-room (at opposite corners of the room); weather-proof units may be plugged into outlets either on starboard or port side of the promenade deck, for dancing. Each reproducer is equipped with its own volume control, of the constant-impedance type.

THE RADIOTRON MERCHANDISER

AFTER 18 months of testing and experimentation, the "radio merchandiser" illustrated above has been developed. Free copies of a booklet listing station calls, etc., and calling attention to the "free tube-testing service" offered by the dealer, are distributed.

Every single detail in the design of the merchandiser has been developed in the light of good sales practice; and use of the finished device, illustrated, should help greatly to boost tube sales.

When the customer brings tubes in for test, every step in the procedure may be followed, including the usual meter tests and, in addition, an actual operating test

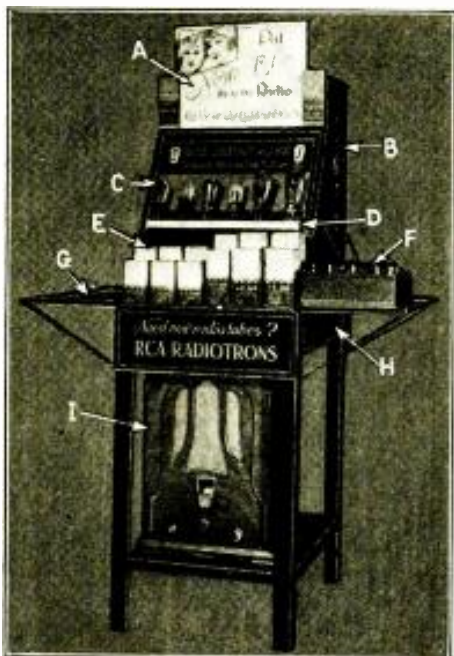

The latest device for increasing tube sales is the "tube merchandiser"; one of two models being illustrated above.

GREATEST TUBE SALE OF 1931

THE LARGEST VARIETY OF TUBES IN THE WORLD

All tubes are guaranteed to be first-grade quality comparable to the best obtainable on the market today. We will replace within 30 days any tube that has not given complete satisfaction. Such an amazing tube sale has never been conducted.

COMPLETE STOCK ALWAYS READY FOR IMMEDIATE SHIPMENTS

Order from this page and note the following terms: No order accepted for less than \$5.00. It is not necessary to send the full amount of cash with the order as long as your order is accompanied by 20% of the value. Shipment will go forward to you by express or parcel post C. O. D. All prices are F. O. B. Factory, Newark.

UX-201A30	Special radio frequency 201A—	
UX-22630	a super-sensitive 201A.....	.60
UY-22730	Special audio frequency 201A—	
UX-171A30	a super-sensitive60
UX-21030	Special 171A* 1-2 amp. extra	
UX-12940	coated filament60
UX-19940	T-11 (210A High Mu) high emfs	
UX-19940	slut60
UX-199 Standard		Switch tube, 201A or 112 or 171	
base.....	.40	double life—all in one.....	.60
UX-11240	Adapter tube 226, 227, 171A, to	
UX-112A40	convert bat. sets to AC, each.....	.60
UX-200A40	UX-210—For power amplifier.....	1.10
UX-22449	UX-250—Power amplifier.....	1.10
UX-24540	Balloon tube	1.00
Quadrole 5-prong		UX-222—Screen grid	1.10
201A for special		Tellon Television Tube 1" Cath-	
circuits50	ode Square	3.85
Special detector		Tellon Television Tube 1 1/2"	
tube 200A—a		Cathode Square	3.85
super-sensitive		Photoelectric cell "Caesium,"	
detector60	Size overall 3 1/16"	5.85
Size overall 3 1/4"		Photoelectric cell "Potassium,"	
Size overall 3 1/4"		WD-11—Detector Amp.....	.60
Rectifier and charger bulbs		WD-12—Detector Amp.....	.60
127 MIL. rectifying tube (R. H. type).....	\$1.40		
6-10 amp. trickle charger bulb.....	2.00		
2 amp. old and new type charger bulbs (list \$1.00),			
our price (Tungar Type).....	2.00		
5 and 6 amp. old type charger bulbs (list \$8.00), our price (Tungar Type).....	3.75		
UX-280—Used as a full-wave rectifier.....	.40		
UX-281—Half wave rectifier.....	1.10		
Rectifying Tube especially designed for use with Freshman Master "B"			
Eliminators UV brass base, limited quantity30		
UX-366—Half-wave Rectifier mercury vapor.....	5.00		

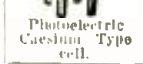

Photoelectric Caesium Type cell.



NEW TYPE TUBES

UY-236—Screen Grid Radio Freq.	.85
UY-237—Detector Amplifier85
UY-238—Power Amplifier Pentode85
UX-230—Dry cell amp. and de-	
rectifier60
UX-231—Dry cell amp.60
UX-232—Dry cell screen grid	
amp.60
UY-247—Power pentode.....	.85
UY-235—Super control screen	
grid amp.85
UY-551—Variable Mu85

DISCOUNTS: 100 tubes and over 10%. 500 tubes and over 10% and 10%

ARCO TUBE COMPANY 38-40 PARK PLACE, NEWARK, N. J.

SERVICE MEN IMPROVE YOUR BUSINESS

By Keeping Your Name Before Your Customers Every Day

FRONT

RADIOMINDER	
1	
2	
3	
4	
5	
6	
7	
8	
9	
10	
11	
12	
13	
14	
15	
16	
17	
18	
19	
20	

Most people don't remember the day, the station, the dial number and hour of their favorite programs and will appreciate a Radiominder Card with spaces to record such information. It will be kept for the longest time in any home. Give Radiominder Cards with your ad printed on to your customers or place one in every home in your neighborhood and they will constantly remind the people of you and thus think of you.

There's No Better Way To Make People Think of You Every Day

These cards are far superior to business cards and their cost insignificant considering the benefits you will derive. Orders accepted for as little as

100 Radiominders with your Ad of 5 Lines Printed for **\$1.25** Each additional 100 Cards 50c Postpaid

Card size 3 1/2 x 7 1/2 inches. Ad space 1 x 3 inches. Printed attractively on heavy Golden Rod Bristol Card. Use ink and handprint your copy and mail with remittance to

Dept. C—ROTH PRESS, 846 Sutter Ave., Brooklyn, N. Y.

BACK

1	
2	
3	
4	
5	
6	
7	
8	
9	
10	
11	
12	
13	
14	
15	
16	
17	
18	
19	
20	

COURTESY OF
Your Ad
will appear here

of the tubes in a standard radio receiver. Features of the merchandiser are: (A), four-way lighted sign, which illuminates the tube tester and also calls attention to the free testing service; (B), space, at rear, for new tube stock, wrapping materials, etc., under lock and key; (C), display of main tube styles, to facilitate selection; (D), current outlets for tube checker; (E), space for tubes most frequently called for; (F), shelf for tube checker; (G), shelf for wrapping; (H), drawer for returned tubes; (I), standard receiver chassis for checking tubes in actual radio performance.

GOLD-CONTACT MICROPHONES

MODERN microphones embody many design improvements. For instance, microphones made under the trade name of "Universal" employ a process by which a sheet of 24-carat gold is stamped on the

surface of a duralumin diaphragm. This process is superior to gold-plating the diaphragm (where the plating flakes off the diaphragm) and prevents corrosion at the contact of diaphragm and carbon granules; since plated gold is porous to the corrosive acids in the air.

TABLE OF TRANSMITTING CONDENSERS

A MATEUR transmitting enthusiasts and commercial designers may obtain "Release No. 130," entitled, "Convenient Tables for Selecting Transmitting Condensers," listing the various types of Cardwell transmitting condensers, for tuning and neutralizing, to be used under various tube and power limitations, by writing to Allied Engineering Institute, Suite 541, 98 Park Pl., N. Y. C.

Hotel Directory of the Radio Trade

THE HOTELS ON THIS PAGE ARE
PATRONIZED BY THE RADIO TRADE.
MAKE THEM YOUR HEADQUARTERS

One in a Thousand



At 999 hotels in Atlantic City
you can get the same thing . . .
rooms with or without meals . . .

*An Original and Unique
Service has made

THE CAROLINA CREST

The Thousandth Hotel

*Abed or at your service table
enjoy a delicious Tray Breakfast
WITHOUT CHARGE—in the
privacy of your own comfortable
room while you glance through
your morning paper . . . then
wonder—as all our guests do—
how we happened to move your
home to the

CAROLINA CREST

North Carolina Ave., near Boardwalk
ATLANTIC CITY, N. J.

RATES:

Single—\$4 and \$5
Double—\$7 and \$8

Every room with private bath—
Bed lamps and at least three windows.

IT'S WISE TO MAKE RESERVATIONS
IN ADVANCE

A riotously gay new revue at
Connie's Inn featuring the
finest in colored entertainment!
Dance-compelling
music by Fletcher Hender-
son and his orchestra.

CONNIE'S INN
131st St.—7th Ave., N. Y. C.
Tel. Tillinghast 5-6630



Here Is The Hotel

nearest to the Merchandise Mart and the
wholesale district . . . on La Salle Street,
the financial center . . . in the theatre
district, two blocks from the new Opera
House . . . and close to the State Street
Stores.

Large, light rooms . . . super-comfort
beds . . . soft water for your bath . . .
silent mail signals in each room . . . four
distinctive dining rooms . . . nationally
known for Good Food. Write for book-
let with downtown map.

Rooms with bath,
\$3.50, \$4.00, \$4.50, \$5.00 and \$6.00.
Rooms without bath, \$2.50.

**NEW
BISMARCK
HOTEL CHICAGO**
RANDOLPH AT LA SALLE

"AN ADDRESS OF DISTINCTION"

**Exceptional
in Every Detail**

THE finer character of THE
DRAKE accommodations,
foods and service is reflected
in the continued patronage
of seasoned travelers . . . and
in the extra comfort the
guest enjoys. Rates begin at
\$4.00 per day. Permanent
Suites at Special Discounts.

**THE
DRAKE
HOTEL, CHICAGO**
Under Blackstone Management

**THE
NEW HOTEL
LINCOLN**
EIGHTH AV.—44th 45th STS.
Just a Step from B'way
NEW YORK CITY

The New and Beautiful
HOTEL LINCOLN
You are assured of MAXIMUM
COMFORT and MAXIMUM
SERVICE

1400 Rooms, each with tub and
shower-Servidor

SINGLE:
\$3.00, \$3.50, \$4.00, \$5.00
DOUBLE:
\$4.00, \$5.00, \$6.00, \$7.00

RADIO—DeForest Direct—now
being installed in every guest room

**ROY MOULTON
MANAGER**

STOP SHOPPING!!

HERE'S a NEW plan, which saves you money. Stop shopping—the lowest prices are right on this page. Yes, lower than in our own catalog. Why? Because no house can get out a new catalog every month, but by advertising in this magazine we can bring

you the latest and lowest prices up to the time this ad is printed. We watch our competitors and do not allow anyone to undersell us. We meet ANY price on NEW merchandise. Order direct from this page and save money. 100% satisfaction on every transaction.

Patent "250" Power Auditorium Amplifier

One of the Most Powerful Super Power Amplifiers ever made.

Now \$8.75



CONTAINS 2 STAGES SUPER POWER A.F. AMPLIFICATION
This famous amplifier is provided with input and output transformers for working from a phonograph pick-up into a 2000-ohm transmission line or into the coupling transformer furnished with most dynamic reproducers. The tubes required are one '26, one '50 and one '81 rectifier. Where maximum output is not required a '10 may be substituted for the '50 in the output. Automatic adjustment takes care of the discrepancy in voltages. The undistorted power output is 2.5 watts—enough for four small dynamic reproducers. This degree of power output provides satisfactory coverage for auditoriums having a volume of 25,000 cubic feet. The input voltage necessary to provide maximum output is but .025 volts.
Ideal for theatres seating approximately 3,000 people, dance halls, schools, lectures, hospitals, auditoriums, outdoor gatherings, etc., etc. The gigantic power is at all times within control—for that matter, it can be used in any home, as the volume can be regulated down to a whisper.
A PHONOGRAPH AMPLIFIER—PUBLIC ADDRESS AMPLIFIER SYSTEM, ETC.
Use of the '26 tube in the input stage makes the long "warm-up" period unnecessary. Shipping weight, 29 lbs. Overall size, 16 x 9 1/2 x 6 3/4" high. List Price, \$90.00.
No. 1925—Patent Model 250 Power Amplifier (less tubes). Your Price **\$8.75**



NEW READRITE Analyzer

This three-meter analyzer has selector switch for checking all parts of tube circuits by connecting to the set sockets. Selection for testing voltages of plate, grid, cathode and screen-grid done quickly and accurately. Plate current, filament volts, line and power supply volts are measured. Grid swing test for tubes used Just push one button for screen-grid and other button for other tubes. Makes testing of all tube tubes simple and thorough. 4 1/2-volt grid battery is furnished. Battery is used for grid test and continuity testing of transformers, chokes, etc. Capacity and resistance charts furnished showing use of instruments for testing condensers, also measuring resistances up to 100,000 ohms. Eight scale readings of meters may be used separately with the jack terminals provided. Scale readings are 0-60-100-600 D.C. volts, 0-10-110-500 A.C. volts and 0-20-120 milliamperes. A.C. and D.C. filament voltages are accurately measured on the one meter. Strong case with leatherette covering. Attractive. Compact. Size 10 3/4 x 3 1/2 x 8 inches. Shipping weight 15 lbs. List Price \$25.00.
No. 700—READRITE ANALYZER. YOUR PRICE **\$14.70**

THORDARSON "215" Power Transformer

A Miniature Power Plant — Supplies All ABC Voltages — 80 Watts

In addition to supplying a full 250 volts to the plates and 50 volts to the grids of two type '26 tubes in push-pull, this transformer may be used to light the filaments of seven or eight 2.5-volt filament tubes; and by connecting in series two of the three 2.5-volt filament secondaries it is possible to light 5-volt filaments too. Five secondaries: S1—5 V., 2 Amp.; S2—310 V. Cent. T.; S3—2 1/2 V., 3 Amp.; Cent. T.; S4—2 1/2 V., 10 1/2 Amp.; S5—3 1/2 V., 3 Amp. Cent. T. Just the power transformer for building up a high-grade public address amplifier to use a screen-grid A.F. amplifier to boost the output of a microphone or phonograph pick-up; following this with two stages of push-pull amplification consisting of two '27's in the first stage and two '15's in the second. Bottom of transformer has bakelite panel on which are mounted all taps. It outperforms ANY similar transformer. Many service men keep this model transformer on hand for emergency replacements in hundreds of makes of radio sets. For 110-120 volts, 50-60 cycles. Size: 5 in. high x 4 x 3 1/2 in. Shipping weight, 8 lbs. List Price, \$15.00.
No. 1450—Thordarson Power Transformer. YOUR PRICE **\$3.84**



Free 36 page Radio Treatise No. 23



The new Summer Edition of our greatly enlarged **RADIO SERVICE TREATISE** has just come off the press. If you liked the Winter Issue, you will like this one a hundred-fold. It contains some 75 new hook-ups, circuit diagrams, and some 350 illustrations. **POSITIVELY THE GREATEST BOOK EVER PUT OUT BY ANYONE.** Among the new matters listed are:
VACUUM TUBE TREATISE. with many illustrations; full page Vacuum Tube Average Characteristic Chart; How to Take Care of Your Tubes; How to Connect Phonograph Pick-ups; Improving the Tone Quality of Old Sets; Connecting Additional Loud Speakers; all fully illustrated with diagrams.
Other articles: Modernizing Old Radio Sets; How to Convert Battery to Power Sets; Selection of Tubes; Push Pull Amplifiers; Replacing Audio Transformers; Phono Attachments; How to Choose Power Transformers; Voltage Dividers; Warehouse of Power Transformers; Selecting and Installing Replacement Parts in Radio Sets; Filter Condensers; Retaining Eliminators.
WRITE TODAY. Enclose 2 cents for postage. Treatise sent by return mail.

RADIO MIRROR PENLITE

The Latest and Clearest Tool for Radio Servicemen. The only device that enables you to LOOK AROUND CORNERS or UNDERNEATH inaccessible spots. Your vision is ONLY in a straight line, but with the Mirror-Penlite you can look around a 45 degree angle. You can now look under the whole chassis and see every unit, every wire, every socket, behind condensers, transformers, etc. This is made possible by the powerful pocket flashlight to which is attached a GENUINE DENTAL MAGNIFYING MIRROR. Mirror clips on or off as flashlight can be used alone if desired. The cleverest device yet. Complete with battery and bulb. Shipping weight 6 ozs.
No. 1695—Mirror-Penlite. List Price \$52.50. YOUR PRICE **\$25.00**

NEW! "LITTLE GIANT" DYNAMIC SPEAKER

Absolutely the smallest dynamic speaker that will withstand the strain of modern output power tubes, ever manufactured. Compact, portable and automobile receivers. Measures but 6 1/2 in. long overall, having a 1/2 in. diaphragm and weighing but 1 1/2 lbs. The "Little Giant" has, under test, actually flooded a ten-room apartment with faithfully reproduced music of virtually original tone quality. Field winding has a resistance of 2500 ohms and may therefore be energized by using it as a filter choke in the power pack, thereby serving a double purpose. This last feature makes the "Little Giant" excellently suited for portable A.C. sets, since it does away with filter chokes and thus with considerable weight. Equipped with built-in output transformer to work from any standard output power tube arrangement. Specify the power tube or tubes used when ordering. Shipping weight 5 lbs. List Price \$6.50.
No. 1549. LITTLE GIANT DYNAMIC SPEAKER. Your Price **\$2.50**

Baldwin RIVAL Speaker Unit

A loud speaker unit bearing the world famous Baldwin mark. Designed for use with horn type speakers or with old style phonographs. Complete with cord. Shipping weight 1 lb. **POSITIVELY LOWEST PRICE THIS UNIT HAS EVER BEEN SOLD.**
No. 1520—Baldwin "Rival" Unit. YOUR PRICE **45c**

NEW! NEW!! Superheterodyne S-W Converter



At last a short-wave converter that converts any broadcast set into a superheterodyne short-wave receiver. Employs three '27 tubes and covers from 20 to 115 meters. No plug-in coils! Coil switch is used to cover all wavelengths. Single dial control, no body capacity, no squeaks. This converter has built-in filament transformer to heat the three '27's. All you need to obtain from your receiver is a positive B voltage anywhere from 45 to 180 volts. Voltage is not critical; no modulation of the receiver. So simple a child can operate it. Size 7 x 10 x 5 inches. Shipping weight, 8 lbs. List Price \$25.00.
No. 1614—Super Converter (less tubes). YOUR PRICE **\$14.69**

World-Wide Short-Wave Set NOT A CONVERTER

NEW

A perfect radio short-wave receiver for use between 18 and 200 meters. To put into operation, connect antenna, ground, 15-volt "B" and two No. 6 dry cell "A" batteries, and headphones to the posts provided. Plug in a type '30 tube, and tune in! An ingenious circuit makes possible a 1-coil single-winding plug-in design. This little instrument has the same sensitivity as many big, shielded short-wave receivers costing ten times as much. A power amplifier may be added for any degree of volume. Complete with 4 plug-in coils. Has the vernier dial for precision tuning. **Never has a first class short-wave set sold for so little money.** This short-wave set measures 5 1/2 x 7 1/4 in. high, over all. Ship. weight, 3 lbs. List price, \$12.50.
No. 1666—World-Wide S.-W. Set. **\$6.25** Your Price



6 MONTHS GUARANTEED NEONTRON TUBES

Sold on a 6 MONTHS FREE REPLACEMENT GUARANTEE BASIS, PROVIDING TUBE LIGHTS! All tubes are carefully meter-tested before shipment, and carefully packed. Do not confuse these HIGH QUALITY tubes with any other "low priced" tubes—our low prices are possible because we do a VOLUME business!

NEW					
Choice	Choice	Choice	Choice	Choice	Choice
226	112A	115	222	230	235
227	200A-190X	280	210	231	217
171A	190V-120	171	250	232	238
201A	221		281		236-37
					551

63c ea. 89c ea. 79c ea. 1.58 ea. 1.08 ea. 1.50 ea.

R.C.A. LICENSED TRIAD AND PERRYMAN TUBES

These nationally advertised tubes are guaranteed UNCONDITIONALLY for six months. The prices are slightly higher than our NEONTRONS because these tubes are of much better quality. See listing above for tube numbers.

Choice Price	Choice Price	Choice Price	Choice Price	Choice Price	Choice Price
76c	96c	86c	\$1.76	\$1.46	\$2.09

Flewelling-Dayton SW Adapter

This wonderful instrument connects to any A.C. radio set by putting into tube socket in place of the tube which must be a type '27, or "heater" tube the plug which is on the end of its 2-ft. cable; then put tube into tube-socket of adapter. Remove aerial from broadcast set and connect to antenna post on adapter. Special plug-in coil No. 1 covers a wavelength band of 17 to 23 meters; coil No. 2, 27-29 meters; coil No. 3, 17-24 meters. Plug in coil inductionances come with the adapter, 5 1/2 x 7 1/4 x 1 1/2" high, overall. Ship. weight 4 lbs.
No. 1613—Dayton Flewelling Short-Wave Adapter. List Price, \$15.00. YOUR PRICE (without tube) **\$4.93**



Short-Wave Converter

Build a short wave converter at lowest price on record, but with which excellent results are obtainable nevertheless. The voltage for the three '27 tubes used may be obtained from an external filament transformer or from a secondary winding of 2 1/2 volts in a power pack. Wavelengths from 30 to 110 meters. No plug-in coils; coil switch is used to cover wave band. Single dial tuning, no grinding, no body capacity, no squeaks. Leak-condenser modulation. Converter consisting of all parts (less filament transformer) including cabinet, panel, diagram and 1-page instruction sheet (less tubes).
No. 1619—YOUR PRICE **\$4.85**
No. 1615—6-Volt Battery Model, same price.



High-Voltage Condenser Units

We guarantee these condensers unconditionally. They are ideal for general replacement purposes and can be installed in any new power-pack. All condensers are furnished with 8-inch lengths of tinned "push-back" wire.

600 VOLTS			800 VOLTS		
Cat. No.	Mfd. Year	Price	Cat. No.	Mfd. Year	Price
1702	1/2	\$0.25	1708	1	\$0.40
1703	1	.30	1707	2	.70
1704	2	.40	1708	4	1.05
1705	4	.60			

WE ARE A WHOLESALE HOUSE AND CANNOT ACCEPT ORDERS FOR LESS THAN \$3.00. If C. O. D. shipment is desired, please remit 20% remittance, which must accompany all orders. If full cash accompanies order, deduct 2% discount. Send money order—enclosed check—U. S. stamps.

Radio Trading Co.

23 West Broadway New York, N. Y.

ORDER FROM THIS PAGE. You will find special prices from time to time in this magazine. Get our big FREE catalog for the greatest Radio Bargains. Should you wish goods shipped by parcel post, be sure to include sufficient extra remittance for same. Any excess will be refunded.

OXFORD DYNAMIC CHASSIS



These speakers are noted for tone without hum. D. C. models can be supplied with push-pull output transformers. A. C. Models with 280 tube as rectifier.

- 14" Audit \$12.95
- 12" Concert Dynamic 8.95
- 9" midget A. C. Dynamic 7.50
- D.C. and A.C. Field Chassis

- 14" 5000 ohm field... \$7.95
- 11 1/2" 2500 ohm field.. 4.95
- Midget 1000 ohm field 3.49
- Midget 2500 ohm field 3.49
- Midget 2500 ohm is supplied with hum balancer.

JENSEN DYNAMIC CHASSIS

Jensen Dynamics are used by leading manufacturers in their sets. We can supply most of their models.



A. C. MODELS

- D8 A. C. rectifier.. \$14.95
- Jr. Audit. tube as rectifier Midget using 280 tube 12.95

D. C. MODELS

- D7 2500 ohm field 12" \$8.95
- D7 1000 ohm field 12" 8.95
- Midget 2250 ohm field 5.95

PENTODE ADAPTER

This Pentode Adapter permits the insertion of a type 247 Pentode Power Tube in place of the type 245 tube. Simply remove 245 tube, and insert the Adapter, and plug in the 247.

OUR NET PRICE

\$1.20



A-B-C POWER PACKS

There are now available to the Service Man, experimenter, and custom set builder three models of power packs designed to supply "A," "B," and "C" potentials to radio receiver chassis of almost any type. Each pack is complete with voltage divider, filter condensers, filter choke, by-pass condensers, and taps for intermediate voltages (R.F., Detector, A.F., etc.) Two leads are provided for connection to a dynamic reproducer field; or the circuit may be completed through a filter choke supplied with each instrument, where the reproducer is a magnetic, or self-powered dynamic unit.

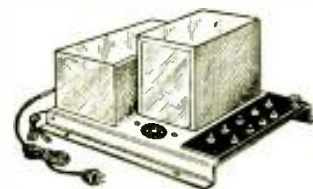

Pentode, screen-grid, variable-mu, and all the other tubes may be powered from one of these packs. The characteristics of each are as follows:

- Type A.** Filament supply for four type '26 tubes, one '27, two '71A's, and an '80. Plate Potential, 180 volts; and the "C" voltage requisite for type '71A tubes.
- Type B.** Filament supply for four type '24 or '27 tubes, two '45's and an '80. Plate potential, 180; and "C" for the '45's.
- Type C.** Filament supply for four type '24 or '27 tubes, two '47 pentodes, and an '80 rectifier. Plate potential, 250 volts; and "C" for the '47's.

Each of these units is provided with taps supplying the usual R.F., detector, and A.F. voltages. These A.B.C. Power Units are going like hot-cakes

OUR PRICE FOR ANY TYPE

\$6.75

MAGNETIC CHASSIS, IN BOSCH CABINETS



Due to the many battery operated sets still in use which require magnetic speakers, we offer the following in the beautiful Bosch cabinet.

Bosch Chassis

- B. B. L. Chassis..... \$4.95
- Utah Chassis 4.95
- R. C. A. Chassis..... 4.95
- Farrand Chassis 4.50

FARRAND Inductor Dynamic

One of the best sounding speakers you ever heard. Words cannot describe the tone of this speaker. No danger of hum, noise of electricity and yet is superior to many dynamic speakers. Two models. 9", \$6.95; 12", \$7.95.



POWERTONE Microphone Stands

Powertone Elec. Co. has now entered the microphone field with a complete line of microphone stands. We are in a position to supply any type of stand. The above stand is 12" high.

Your Price \$3.50

R.C.A. MODEL CHASSIS

Famous R.C.A. chassis in models for every set.



- A. C. Model 106 with 280 tube.. \$12.50
- D. C. Model, 330 volt field, 1000 ohm, with output trans..... 5.50
- Same as above less transformer.. 4.50
- Model 106 12" 2500 ohm field.. 7.50

BALDWIN DYNAMIC CHASSIS

Made by the famous Nathaniel Baldwin 9" A.C. with 280 tube \$7.50 9" D.C. 2000 ohm & sta 5.50 9" D.C. 2000 ohm without stand 4.00 9" D.C. 2000 ohm less output trans. 3.25 This speaker is noted for its fidelity of tone and sensitivity.



B.B.L. SCRATCH FILTER



It is now possible to filter out scratch produced by the needle as it rides over the grooves with the B.B.L. scratch filter. Price35c

All offers are F.O.B. New York, and subject to prior sale. Terms: A deposit of 20% is required with every order. Balance may be paid on delivery. Or, deduct 2% if full amount is sent with order.

DO NOT WRITE FOR CATALOG!

GRENPARK CO., Dept. RC. 245 Greenwich Street, New York, N.Y.

\$

Prices YOU can make a REAL profit on!

\$

Famous Model "G" Gordon Phono-Motor and Turntable

First time at this price. Ruggedly constructed throughout. Spanish felt gears assure silence. Equipped with automatic stop control. Induction type, no brushes. Easy to install—exceptionally quick starting torque. For 110 volt 60 cycle alternating current. Proven dependability has made this New Gordon Electric Phonograph Motor and Turntable the accepted standard of excellence for the industry.

First time at this price. Make a nice profit and build good will with everyone.



List \$30.00
OUR PRICE \$8.95

Farrand Dynamic Chassis

Famed for its simplicity and reliability. Easily installed in all types of radio or phonograph consoles. Tonal range and fidelity superior to any other reproducing unit in general use. Dimension: Height 9 inches, width 8 3/4 inches, depth 7 inches. For A.C. current.

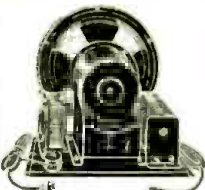

OUR PRICE \$5.95

Condenser Block for Majestic "B" Eliminator



OUR PRICE \$2.75

Replacement for defective blocks in "B" Eliminators—identical in electrical characteristics and outside dimensions. Can also be used in any make "B" Eliminator as well as most power packs

Gordon Acme 4 Pick-Up with Volume Control

Genuine Bakelite arm with beautiful natural wood finish will not show wear as will plated metal. Faithfully reproduces the entire musical range.

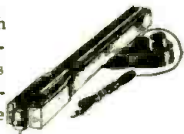

OUR PRICE \$4.50

I.C.A. Test Leads—a necessity to the dealer or serviceman. Unsurpassed for testing sets and tracing shorts, opens and other common defects. Easily attached to testing meter or electrical apparatus. **40c**

Fixed Pigtail Resistors

	OHMS	
500	10,000	75,000
1,000	15,000	100,000
1,500	20,000	125,000
1,800	25,000	150,000
4,000	30,000	250,000
4,700	40,000	1 Megohm
5,000	60,000	2 Megohms

OUR PRICE 75c PER DOZ

R. C. A. Loudspeaker 103

A beautiful speaker, superb in its faithful reproduction. Molded frame and pedestal resemble hand carved oak. Mechanism concealed by attractive tapestry.



(Genuine R.C.A.)
List \$18.00
OUR PRICE \$3.50

Atwater-Kent

Condenser & Filter Block

For Model 37 and 38 Sets

Ideal filtering system for ANY make A. C. set using 171-A tube. Contains proper chokes and high voltage condensers. Flexible wire colored leads same as original.

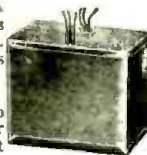

HOOK-UP
Green wire to 280, black to R.F. plate, yellow to Power Tube plate, white to first audio by-pass, white to C.T. of 226 resistance, red to detector OUR plate. Wire from PRICE can to ground.

\$2.95

Kolster K-6 Speaker

Magnetic type cone speaker. Remarkable tone quality; volume to spare. Beautifully carved, fine Walnut cabinet. Equipped with highly sensitive oversize magnet and driving unit. Faithful reproduction from the faintest whisper to fullest volume of a brass band.



List \$20.00
OUR PRICE \$3.35

AIR-KING

Superheterodyne S.W. Converter

The greatest converter ever built.

Brings in European stations clear as a bell. Converts any set into a short wave receiver. Employs 3-227 tubes; covers from 20 to 115 meters. Coil switch covers all wave lengths. Single dial control, no bulky capacity, no squeals. Has built-in filament transformer to heat the 3-227's. All you need from your receiver is a positive B. voltage from 15 to 180 volts. Voltage is not critical; no molestation of the receiver. Size 7x10x5 in. Weight 8 lbs.

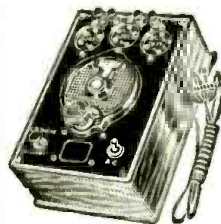

OUR PRICE \$14.70

New Type Elkon Dry Disc Rectifier

Standard on "A" Eliminators for Majestic, Mayolian, Webster, Elkon, Bernard, Fada, Knapp, Sentinel, Metro, General Instrument, Philco (Elkon equipped) and also on Elkon 3 amp., and Briggs & Stratton chargers.

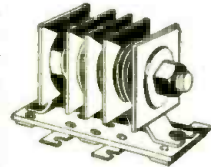

List \$7.00

OUR PRICE \$3.45

Baldwin Rival Unit



This Nathaniel Baldwin unit is one of the finest. For phonograph, automobile and portable radio outfits. We offer this famous unit now at a sensationally reduced price.

OUR PRICE 50c

VICTOR ABC Power Transformer

For use with 6-226, 2-245, 1-227 and 1-280 tubes. Magnetically shielded preventing hum. Can safely be overloaded 30%. High voltages, 400 volts at 150 mls on either side of center tap. Extra large case especially designed to prevent overheating.

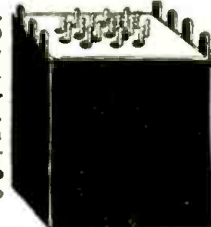

Can Be Used For Any Power Amplifier Using 245 Tubes

Size: 4 1/2 x 5 x 5 1/2 inches.
No. 1—Center tap of 9 and 14 (5 volts).
No. 2 and 4—2 1/2 Volts.
No. 5 and 7—1 in. V. High amp. (226).
No. 3 and 6—Primary (110V. input).
No. 8—Center tap of 12 and 17 (2 1/2 V.)
No. 9 and 14—5 Volts (280).
No. 10 and 15—High voltage for B supply.
No. 16—Center tap of above.
No. 12 and 17—2 1/2 in. volts high amp. (224).

OUR PRICE \$2.10

FREE Catalog—means money to you

These are only a few samples of the values to be found in our catalog. It is full of items on which you can make from 50% to 300% profit. And the best of them is, they are sound, well known, trademarked articles you can depend upon.

Send 20¢ with the order and articles will be shipped C.O.D. Order any of the above articles direct from this page. And be sure to ask for the catalog. It means money to you!

RADIO CIRCULAR CO.

225 Varick St. New York City

ORDER DIRECT...from this page!

TEAR IT OUT NOW!

RADIO CIRCULAR CO., 225 Varick Street, New York City

Enclosed find \$..... This is 20% of items listed below. I will pay balance upon receipt of merchandise. We regret that we cannot accept orders under \$5.00.

Send for FREE catalog!

RADIO CIRCULAR CO.
225 Varick Street, New York City

Please send me your catalog of radio bargains I can make a profit on.
I understand this obligates me in no way.

Name

Address

City

State

Also please send catalog.



J. E. Smith, President, National Radio Institute, the man who has directed the Home-Study training of more men for the Radio Industry than any other man in America.

YOU'RE WANTED *for a* Big Pay Radio Job

I'll Train You at Home in Your Spare Time
for **RADIO · TELEVISION · TALKING MOVIES**



Set Servicing

Spare-time set servicing is paying N. R. I. men \$200 to \$1,000 a year. Full-time men are making as much as \$65, \$75 and \$100 a week.

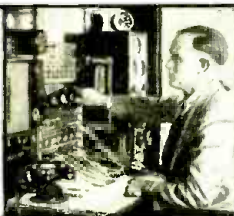

Broadcasting Stations

Need trained men continually for jobs paying \$1,200 to \$5,000 a year.



Ship Operating

Radio operators on ships see the world free and get good pay plus expenses.

Aircraft Radio

Aviation is needing more and more trained Radio men. Operators employed through Civil Service Commission earn \$1,620 to \$2,800 a year.



Talking Movies

An invention made possible by Radio. Offers many fine jobs to well-trained Radio men, paying \$75 to \$200 a week.



Television

The coming field of many great opportunities is covered by my course.



I F YOU are earning a penny less than \$50 a week, send for my book of information on the opportunities in Radio. It is free. Clip the coupon NOW. Why be satisfied with \$25, \$30 or \$40 a week for longer than the short time it takes to get ready for Radio?

Radio's Growth Opening Hundreds of \$50, \$75, \$100 a Week Jobs Every Year

In about ten years Radio has grown from a \$2,000,000 to a \$1,000,000,000 industry. Over 800,000 jobs have been created. Hundreds more are being opened every year by its continued growth. Men and young men with the right training—the kind of training I give you—are stepping into Radio at two and three times their former salaries. J. A. Vaughn, 3107 S. Grand Boulevard, St. Louis, Mo., writes: "Before I entered Radio I was making \$35 a week. Last week I earned \$110 selling and servicing sets. I owe my success to N. R. I."

You Have Many Jobs To Choose From

Broadcasting stations use engineers, operators, station managers and pay \$1,200 to \$5,000 a year. Manufacturers continually need testers, inspectors, foremen, engineers, service men, buyers, for jobs paying up to \$7,500 a year. Radio Operators on ships enjoy life, see the world, with board and lodging free and get good pay besides. Dealers and jobbers employ service men, salesmen, buyers, managers, and pay \$30 to \$100 a week. There are many other opportunities too.

So Many Opportunities Many N. R. I. Men Make \$200 to \$1000 While Learning

The day you enroll with me I'll show you how to do 28 jobs, common in most every neighborhood, for spare-time money. Throughout your course I send you infor-

I give you 8 Outfits of Radio Parts for Practical Home Experiments

You can build over 100 circuits with these outfits. You build and experiment with the circuits used in Crosley, Atwater Kent, Eveready, Majestic, Zenith, and other popular sets. You learn how these sets work, why they work, how to make them work. This makes learning at home easy, fascinating, practical.

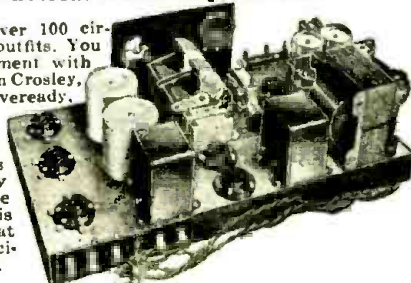

mation on servicing popular makes of sets; I give you the plans and ideas that are making \$200 to \$1,000 for hundreds of N. R. I. students in their spare time while studying. My course is famous as the one that pays for itself. G. W. Page, 133 Pine Street, McKenzie, Tenn., writes: "I picked up \$935 in my spare time while taking your course."

Talking Movies, Television and Aircraft Radio are Also Included

Special training in Talking Movies, Television and home Television experiments. Radio's use in Aviation, Servicing and Merchandising Sets, Broadcasting, Commercial and Ship Operating are included. I am so sure that I can train you satisfactorily that I will agree in writing to refund every penny of your tuition if you are not satisfied with my Lessons and Instruction Service upon completing.

64-page Book of Information Free

Get your copy today. It tells you where Radio's good jobs are, what they pay, tells you about my course, what others who have taken it are doing and making. Find out what Radio offers you, without the slightest obligation. **ACT NOW!**

J. E. SMITH, President
National Radio Institute
Dept. 1-NX
Washington, D. C.



THIS COUPON IS GOOD for
One FREE COPY OF MY BOOK *mail it now*

J. E. SMITH, President
National Radio Institute, Dept. 1-NX
Washington, D. C.

Dear Mr. Smith: Send me your free 64-page book, "Rich Rewards in Radio." I understand this does not obligate me and that no salesman will call.

Name.....
Address.....
City.....State.....

NOW

On All Newsstands

25c The Copy

4-Color Cover
Over 100 Illustrations
96 Pages—9x12 in.

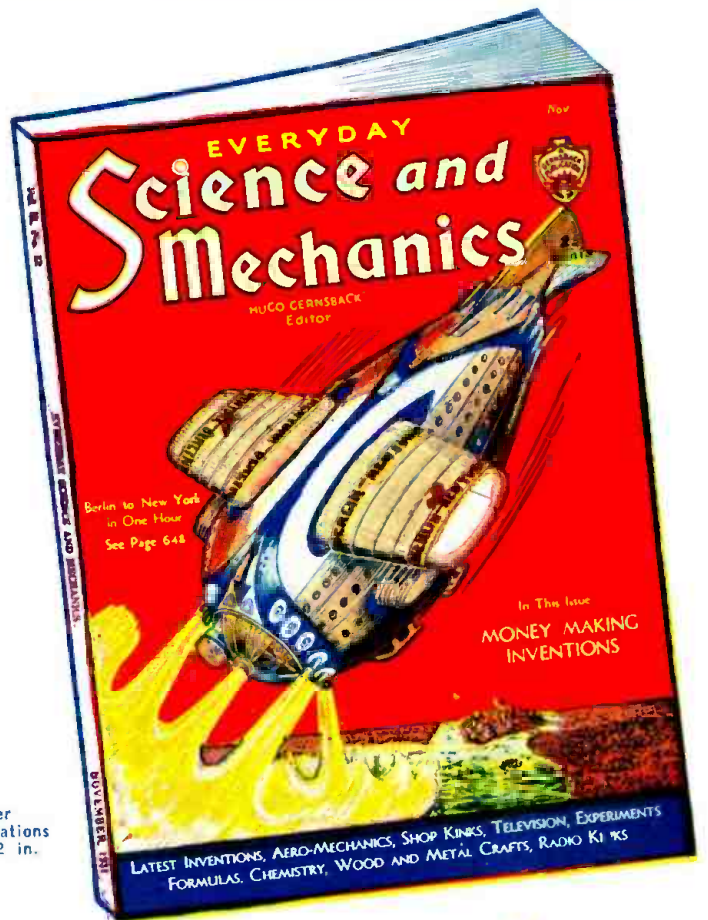

**TO MY RADIO FRIENDS
WILL YOU BET 25c ON ME?**

I want to ask you, as a special favor, to stop at your nearest newsstand and get an issue of **EVERYDAY SCIENCE AND MECHANICS** on the following unprecedented arrangement: Take the magazine home, look it over carefully and read those articles which are of interest to you. If, when you finish reading the magazine, you have found that you haven't had your money's worth, you may return the magazine to me and I will immediately refund your quarter, plus postage which you paid in returning the magazine.

I am making this unprecedented offer simply to get you acquainted with the magazine, and because I honestly believe that every issue of **EVERYDAY SCIENCE AND MECHANICS** will be worth many dollars to you with the important information you can't get elsewhere.

RADIO AND TELEVISION

I want you to look particularly at the new radio and television section containing a tremendous amount of information for radio experimenters, of the kind you cannot possibly get elsewhere.

This special offer to you is good during the month of November only. I hope you will do me the favor to take me up on this unprecedented proposition. Won't you please write and tell me how the book strikes you?

Cordially yours,
H. GERNSBACK.

EVERYDAY SCIENCE AND MECHANICS

100 Park Place, New York, N. Y.

RECAPTURE
the THRILL of
 EARLY RADIO
 RECEPTION

Hear the
*Short-Wave Stations
 of the World: direct*
 With the **NEW PILOT**

SUPER-WASP

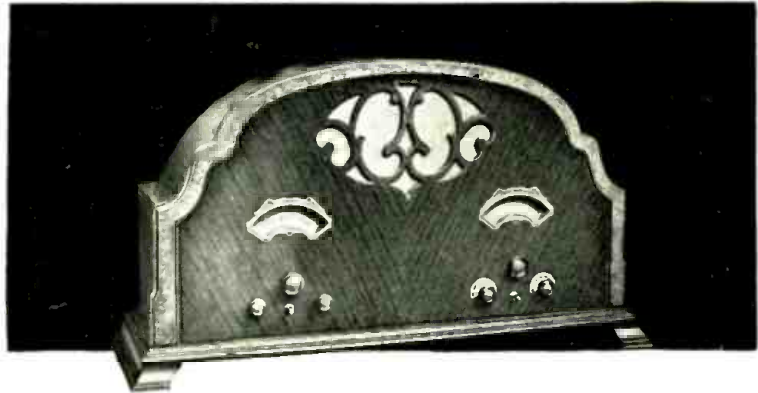

This 4-tube Short-Wave Converter transforms any modern radio receiver into a short-wave set instantly. Complete with newest type tubes, including rectifier.

\$39.50

Day or night, Pilot's marvelous SUPER-WASP brings in all kinds of new and startling things—airplane-to-ground conversations, transoceanic telephone calls, foreign broadcasting stations and, most exciting of all, police headquarters in a dozen cities talking to their radio-equipped "emergency cruisers." This 11-tube Super-heterodyne has separate controls for the broadcast band, with special high quality, high selectivity circuit. Including newest type tubes and built-in dynamic speaker. **\$99.50**

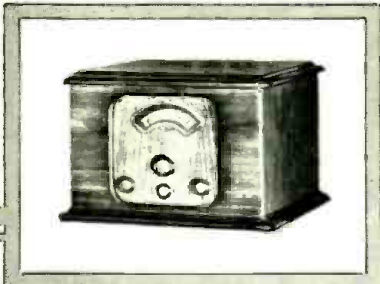

Pilot Radio & Tube Corporation
 Lawrence, Mass.

Please send me complete information about:

- The new SUPER-WASP
- The 4-tube Converter
- I enclose 50c for one year's subscription to Radio Design beginning with the current issue.

Name.....City.....State.....